

# ABOUT CROUZET

100 YEARS MANUFACTURING THE FUTURE *Together*

Crouzet is an independent company manufacturing mechatronic components for demanding applications in Aerospace & Transportation, Energy, Building & Machinery Industry.

Crouzet provides Switches & Sensors, Electromechanical Actuators, Electrical Control & Protection Equipment, Flight Control Equipment, Automation Controllers & Relays, and Instrumentation Services.

Since 1921, Crouzet has a heritage of close collaboration with customers in the development of products, from standard components to fully customized solutions.

Crouzet's customers and partners can rely on our teams worldwide to always meet and often exceed their expectations. Driven by innovation, our experts are focused on designing and delivering the right product for the right application.

Crouzet is your trusted partner of choice to face the industrial challenges of today and tomorrow.

## WORLDWIDE PRESENCE

10 Manufacturing Plants & 6 R&D Labs

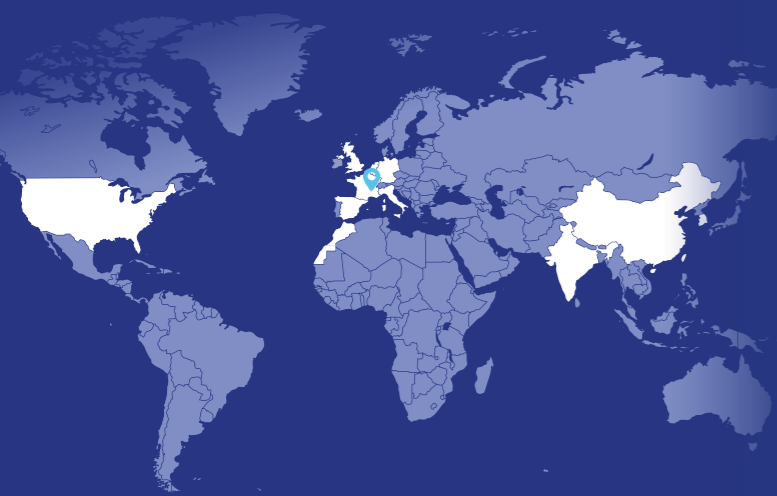

 VALENCE, FRANCE	 PONT-DE-L'ISÈRE, FRANCE
 PARIS, FRANCE	 NANTES, FRANCE
 ORLEANS, FRANCE	 VOUVRY, SWITZERLAND
 CASABLANCA 1, MOROCCO	 CASABLANCA 2, MOROCCO
 HUIZHOU, CHINA	 BANGALORE, INDIA

## Our Services



### 100+ years of customization, adaptation & co-design expertise at your service

When your innovation process needs more than high-quality standard products, we will answer your specific needs by offering you the best customized solution, a long-term partnership commitment and a multidisciplinary team dedicated to your project



High-quality and efficient manufacturing



Uncompromising and highest standards



# Catalog Index



## Timer Relays

- Recent Innovation: UDT P.10
- DIN Rail Mount: Syr-line, Chronos P.12
- Panel Mount: Syr-line, TMR48 P.14
- Plug-In: Syr-line P.15
- Timing Functions P.16



## Monitoring Relays

- Three-Phase Network P.20
- Single Phase Current P.20
- Single Phase Voltage P.20
- Level Control P.20



## Counters

- Electronic P.24
- Electromechanical P.26
- Pneumatic Counters P.28

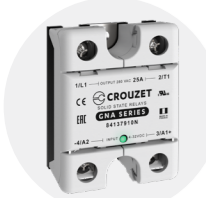

## Solid State Relays

- Discover our full Offer P.32
- AC Voltage: Single Phase P.34
- AC Voltage: Multichannel P.38
- AC Voltage: Three Phase P.38
- DC Voltage P.40
- Load Diagnostic: Smart SSR P.42
- Accessories P.42



## Automation Controllers

- Selection guide P.46
- Recent Innovation: M Evo P.48
- Logic-Controller: Slim, Millenium3 P.50
- Logic Controller: Evo P.52
- Accessories P.52
- Nano PLC: em4 P.54
- Telecontroller: em4 Alert P.54
- Crouzet solft/Virtual Display P.56



## HMIs

- Selection guide P.60
- Crouzet Touch Soft P.61
- Performance P.62
- Essential P.62
- Cables and Expansions/Interfaces P.64



## Complementary Products

- Power Supplies P.68
- Temperature & Signal Converters P.68
- Faceplates P.68
- Temperature Sensors P.69



## Pneumatic Components

- 60 Years P.72
- Switches & Sensors P.74
- Logic Control P.82
- Indicators P.92
- Solenoid Valves P.74
- Circuit Components & Boards P.98

TIMERS

MONITORING RELAYS

COUNTERS

SSR

AUTOMATION CONTROLLERS

HMI'S

COMPLEMENTARY PRODUCTS

PNEUMATIC

# Selection Guide - Timers

## Crouzet's Timers

Crouzet, specialist in Time Delay Relays, has been introducing new timer products and technologies for more than 50 years. Our timers continue to evolve with more features and functionality.

### DIN RAIL MOUNT

Type	Function	Time range	Output	Supply	
 <b>Syr-Line</b> Universal Digital	Super Multifunction Z*	0,1 s → 100 days	1 x 8 A (Changeover)	12-240 VAC/DC	
 <b>Syr-Line</b> High-Power	Multifunction M* + Tt	0,1 s → 10 days	1 x 16 A (Changeover)	12-240 VAC/DC	
	A: ON-Delay				
	L/Li: Repeat Cycle				
 <b>Syr-Line</b> Double Output	Multifunction M* + Instantaneous	0,1 s → 10 days	2 x 8 A (Changeover)	12-240 VAC/DC	
	A: ON-Delay				
	L/Li: Repeat Cycle				
 <b>Chronos 2</b> Classic	Multifunction U*	0,1 s → 100 h	1 x 8 A (Changeover)	12-240 VAC/DC	
	Multifunction U*			24 VDC / 24-240 VAC	
	Multifunction U*			24 VDC / 24-240 VAC	
	Multifunction X*			24 VDC / 24-240 VAC	
	A-At: ON-Delay/ Summation	0,1 s → 100 h	1 x 8 A (Changeover)	24 VDC / 24-240 VAC	
	B: Single Shot				
	C: Off-Delay				
	H/Ht: Interval + Memory	0,1 s → 100 h	1 x 0,7 A (Static)	24-240 VAC/DC	
	L/Li: Repeat Cycle				
	Multifunction U*				
	H/Ht: Interval + Memory	0,1 s → 100 h	2 x 8 A (Changeover)	24-240 VAC	
	L/Li: Repeat Cycle			24-240 VAC/DC	
	A: ON-Delay			24 VDC / 24-240 VAC	
	Q: Star-Delta	0,1 s → 100 h	2 x 8 A (Changeover)	230-240 / 380-440 VAC	
	Q: Star-Delta			20-30 VDC / 20-264 VAC	
K: True Off-Delay	0,6 s → 160 s				

**Super Multifunction Z\*:** (A - Ab - Ac - Ad - Ah - At - B - Bw - C - D - Di - H - Ht - L - Li - O - N - P - Pt - T - TL - Tt - W) + options

**Multifunction M\*:** (A - Ac - At - B - C - D - Di - H - Ht - N - TL)

**Multifunction U\*:** (A - Ac - At - B - Bw - C - D - Di - H - Ht)

**Multifunction X\*:** (Ad - Ah - N - O - P - Pt - TL - Tt)





## Timer Features

- All the most popular functions: on-delay, off-delay, repeat cycle and many more
- Many Options: Analog, Digital, DIN Rail, Panel Mount, Plug-In
- DesignLab for custom adaptations, 100+ years of Engineering expertise at your service.

	Special Characteristics	Width	Mounting	Designation	Part Number
	Universal connections, Timing limits, Password protection, easy to use	17.5 mm	DIN Rail	DZIR	DZIR08MV1
	Protective Cover	17.5 mm	DIN Rail	BM1R	BM1R16MV1
				BA1R	BA1R16MV1
				BL1R	BL1R16MV1
	Protective Cover	17.5 mm	DIN Rail	BM2R	BM2R08MV1
				BA2R	BA2R08MV1
				BL2R	BL2R08MV1
	Spring terminal	17.5 mm	DIN Rail	MURc3	88 827 503
				MUR3	88 827 103
				MUR1	88 827 105
				MXR1	88 827 185
	-	17.5 mm	DIN Rail	MAR1	88 827 115
				MBR1	88 827 125
				MCR1	88 827 135
				MHR1	88 827 145
				MLR1	88 827 155
	Static Output	17.5 mm	DIN Rail	MUS2	88 827 004
				MHS2	88 827 044
				MLS2	88 827 054
	-	22.5 mm	DIN Rail	MAS5	88 827 014
				RQR1	88 866 175
				RQR6	88 866 176
				TK2R1	88 865 265

# Selection Guide - Timers

## PANEL MOUNT

Type	Function	Time range	Output	Supply
 <b>Syr-Line</b> Plug-in	Multifunction U* + Ad, Instantaneous	0,5 s → 10 days	2 x 10 A (Changeover)	12-240 VAC/DC
	A: ON-Delay			
	C: Off-Delay			
	L: Repeat Cycle			
	Multifunction U* + Ad, N		1 x 10 A (Changeover)	
	A: ON-Delay		2 x 10 A (Changeover)	
	C: Off-Delay		1 x 10 A (Changeover)	
	L: Repeat Cycle			
 <b>Syr-Line</b> TMR48D Digital Performance	Multifunction S*	0,001 s → 9999 h	2 x 10 A (Changeover)	12-240 VAC/DC
	Multifunction F*		1 x 10 A (Changeover)	
	Multifunction F*		2 x 10 A (Changeover)	
	A: ON-Delay			
 <b>Syr-Line</b> TMR48D Digital Essential	Multifunction E*	0,001 s → 9999 h	1 x 5 A (Changeover)	24 VAC/DC
	Multifunction E*			100-240 VAC/DC
 <b>TMR48</b> Analog	A, B, C, W, G, Ac, Bw	0,02 s → 300 h	2 x 5 A (Changeover)	12-240 VDC / 24-240 VAC
	L/LI - G/Gi			
	A1, A2, H1, H2, Q1, Q2, D-Di			
	A: ON-Delay			

Multifunction S\*: (A - Ab - Ac - Ad - AMt - At - B - C - H - Ht - L - Li - T - W - D - Di)

Multifunction F\*: (A - Ac - Ad - B - C - H - L - Li - D - Di)

Multifunction E\*: (A - B - C - H - D - Di)

Multifunction U\*: (A - Ac - At - B - Bw - C - D - Di - H - Ht)

## PNEUMATIC & ATEX PNEUMATIC TIMERS

Type	Function	Information
 On Sub-base	Positive	See page 80
	Negative	
	Impulse Generator	
	Frequency Generator	

Special Characteristics	Width	Mounting	Designation	Part Number
Protective Cover	35 mm	11-Pin	PU2R	PU2R10MV1
			PA2R	PA2R10MV1
			PC2R	PC2R10MV1
			PL2R	PL2R10MV1
		8-Pin	OUIR	OUIR10MV1
			OA2R	OA2R10MV1
			OC1R	OC1R10MV1
			OL1R	OL1R10MV1
LED, IP66	48 mm	11-Pin	GDS2	GDS2R10MV2
			GDF1	GDF1R10MV2
		8-Pin	MDF1	MDF1R10MV2
			MDA2	MDA2R10MV2
LCD, IP66	48 mm	8-Pin	MDE1	MDE1R0524U
			MDE1	MDE1R05MVA
-	48 mm	11-Pin	TMR 48 U	88 886 016
			TMR 48 L	88 886 516
		8-Pin	TMR 48 X	88 886 116
			TMR 48 A	88 886 106

## TIMERS' ACCESSORIES

Type	Compatibility	Description	Part Number
 Socket	• TMR48D • TM48 • Plug-In	8-Pin DIN Rail Base	25 622 130
		11-Pin DIN Rail Base	25 622 080
		8-Pin Screw Terminals	25 622 203
		11-Pin Screw Terminals	79 694 002
		8-Pin Solder Plug	25 622 301
		11-Pin Solder Plug	25 622 076
Adaptor	• Syr-Line • Chronos 2	DIN Rail to Panel Mount	79 237 806

# Selection Guide - Timing Functions

## Diagrams

U: Power Supply R: Output Relay T: Timing ∞Infinity C (Y1): Command

### A Function

**ON-Delay**  
After power-up, timing starts, and relay turns ON at the end of timing

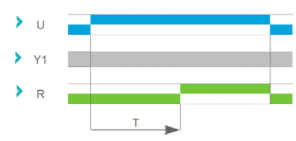

### Ab Function

**Delay Interval**  
After a signal, timing 1 starts and relay turns ON. Then timing 2 starts and relay turns off

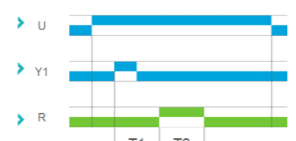

### Ac Function

**On/Off Delay**  
After a signal, timing 1 starts and relay turns ON. After signal is removed, timing 2 starts and relay turns OFF



### Ad Function

**Delay on Start**  
After a signal, timing starts, and relay turns ON at the end of timing

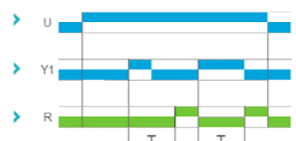

### Ah Function

**Triggered Flashing Cycle**  
After a signal, timing starts, and relay turns ON. Then timing starts again, and relay turns off

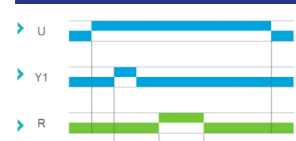

### At Function

**Summation time relay**  
After absence of an input signal equals the selected time, relay turns ON

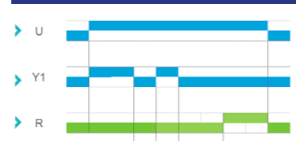

### B Function

**Single Shot**  
After a signal, relay turns ON and timing starts; At the end of the timing, relay turns OFF



### Bw Function

**Pulse output**  
Each time a signal changes state; relay turns ON for the selected timing



### L/Li Function

**Repeat Cycle**  
After power-up, a repetitive cycle of independent timing starts  
L: Start in OFF position  
Li: Start in ON position

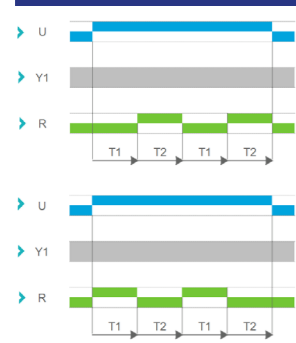

### D/Di Function

**Flasher**  
After power-up, a repetitive cycle of equal timing starts  
D: Start in OFF position  
Di: Start in ON position

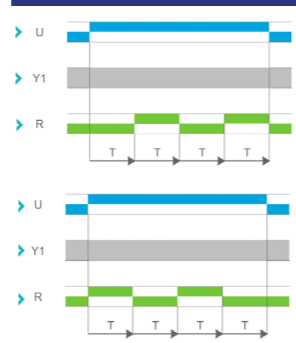

### C Function

**OFF-Delay**  
After a signal, relay turns ON. When signal is removed, timing starts, and relay turns OFF at the end of timing

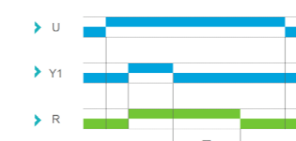

### H Function

**Interval**  
After power-up, relay turns ON and timing starts; At the end of the timing, relay turns OFF



### N Function

**Watchdog**  
After a signal, relay turns ON. When signal is sent, timing resets. If timing is completed relay turns OFF



### Ht Function

**Interval with Memory**  
After absence of an input signal equals the selected time, relay turns OFF

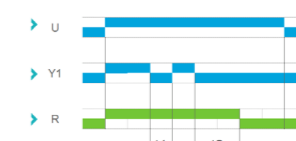

### O Function

**Delayed Watchdog**  
After power-up, timing starts, and relay turns ON at the end of timing. When signal is sent, timing and relay resets



### P Function

**Pulse Delay Relay**  
After power-up, timing starts, and relay turns ON for 500ms at the end of timing

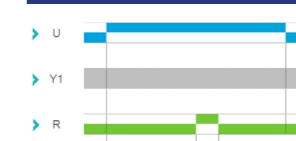

### Pt Function

**Impulse Counter**  
After absence of an input signal equals the selected time, relay turns ON for 500ms

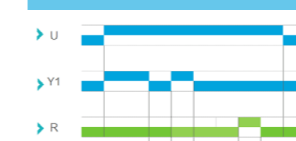

### T Function

**On-Delay: Sum of times**  
After summation of an input signal equals the selected time, relay turns ON

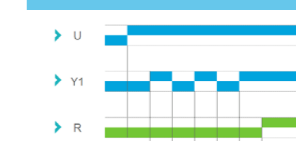

### Tl Function

**Latching**  
Each time a signal is sent, relay changes state

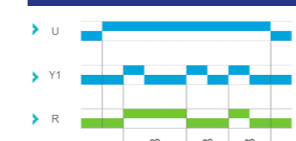

### Tt Function

**Delayed Latching**  
After a signal, relay turns ON and timing starts; At the end of the timing, relay turns OFF. Signal can stop timing



### W Function

**Timing after pulse of control contact**  
After a signal is removed, relay turns ON and timing starts; At the end of the timing, relay turns OFF



For more detailed diagrams or the diagrams of special functions, please visit [www.crouzet.com](http://www.crouzet.com)

# Selection Guide - Monitoring Relays



## Crouzet's Monitoring Relays

In industrial and commercial installations, every device should be monitored by a Crouzet Monitoring Relay to optimize continuity of service. The control relay enables the operator to initiate maintenance operations or corrective actions to avoid expensive production shutdowns.

## Monitoring Relay Features

- Protect AC motors, HVAC Systems, Pumps, Conveyors, Packaging Machines and other loads.
- Many Options: Three-phase and single phase, voltage, current, level monitoring
- UL and CE certified

## ELECTRICAL MONITORING

Type	Function	Measuring Range	Output
 <b>Three-Phase</b>	Voltage	220-480 VAC	1 x 5 A (Changeover)
	Voltage	208-480 VAC	
	Voltage   Absence	120-277 VAC	2 x 5 A (Changeover)
	Sequence   Absence	208-440 VAC	
	Sequence   Absence	208-480 VAC	1 x 5 A (Changeover)
	Sequence   Absence   Undervoltage		
	Sequence   Absence   Imbalance		
	Sequence   Absence   Voltage   Imbalance		
Sequence   Absence   Voltage   Imbalance	220-480 VAC		
 <b>Single phase</b>	Voltage	9-15 VDC	1 x 5 A (Changeover)
	Voltage	0.2-60V AC/DC	2 x 5 A (Changeover)
	Voltage	20-80V AC/DC	1 x 5 A (Changeover)
	Voltage	65-260V AC/DC	
	Voltage	15-600V AC/DC	2 x 5 A (Changeover)
	Current	2-500 mA	2 x 5 A (Changeover)
	Current	0.1-10 A	
	Current	2-20 A	

Power Supply	Width	Mounting	Designation	Part Number	
220-480 VAC	35 mm	DIN Rail	H3US	84 873 220	
			M3US	84 873 222	
120-277 VAC	35 mm		H3USN	84 873 221	
			MW52	84 873 021	
208-440 VAC	17,5 mm		MWG	84 873 022	
			MWU	84 873 023	
208-480 VAC	17,5 mm		MWA	84 873 024	
			MWUA	84 873 025	
			HWUA	84 873 026	
220-480 VAC	35 mm	DIN Rail	MUS	84 872 140	
9-15 VDC	17,5 mm		HUL	84 872 120	
24-240 VAC/DC	35 mm		MUS	84 872 141	
			MUS	84 872 142	
20-80 VAC/DC	17,5 mm		MUSF	84 872 152	
			65-260 VAC/DC	35 mm	HUH
24-240 VAC/DC	35 mm		DIN Rail	HIL	84 871 120
				HIH	84 871 130
				MIC	84 871 122
24-240V AC/DC	17,5 mm				

## LEVEL CONTROL

Type	Function	Measuring Range	Output
 <b>Level</b>	Pump up or down	5 - 100 kΩ	1 x 8 A (Changeover)
	Pump up or down	250 Ω - 1 MΩ	
	Pump up or down	250 Ω - 1 MΩ	2 x 5 A (Changeover)

Power Supply	Width	Probe	Mounting	Designation	Part Number
24-240 VAC/DC	22,5 mm	Resistive	DIN Rail	ENR	84 870 200
				ENRM	84 870 210
	35 mm			HNM	84 870 700

## ACCESSORIES

Type	Description	Compatibility	Part Number
 <b>Probes</b>	Electrode Holder	ENR / ENRM / HNM	79 696 044
	Protected Suspension Sensor		79 696 043
	Electrode & Holder 200°C		79 696 014

# Selection Guide - Counters







## Crouzet's Counters

Count the number of parts, events, or actions or the running time of equipment, to inform or trigger an action or intervention. Very useful for scheduling preventive maintenance on machines or production lines.

## Counter Features

- Great visualization, either by LCD screen, LED screen or Mechanical Dials
- Hour Counters, Totalizers (Impulse Counters), Preselection, Chronometer, Ratemeter
- Many Options: Electronic and Electromechanical, Clip or Screw Mounting, different sizes and supply







### ELECTRONIC COUNTERS

Type	Visualization	Inputs	Output	Power Supply
 Hour Counter	LCD	PNP	-	10-260 VAC/DC
	LCD	NPN		Battery
	LCD	Voltage		
	Backlight LCD			
 Totalizer	LCD	PNP	-	10-260 VAC/DC
	LCD	NPN		Battery
	LCD	Voltage		
	Backlight LCD	PNP		10-260 VAC/DC
	Backlight LCD	Voltage		Battery
 Double Totalizer	LED	NPN or PNP	-	10-30 VDC
	LED	NPN or PNP (Common Input)		
 <b>Multifunction 1*</b> (Totalizer Hour Counter Ratemeter)	LED	NPN or PNP	-	10-30 VDC
 Preset Chronometer	Backlight LCD	PNP/NPN/Voltage	1 · 1 x 3 A (Changeover)	10-30 VDC
	Backlight LCD			230 VAC
 <b>Multifunction 2*</b> (Preset Multi-Totalizer Chronometer Ratemeter)	Backlight LCD	PNP/NPN/Voltage	2 · 1 x 5 A (Changeover) + · 1 x 30 mA (SSR)	10-30 VDC
	Backlight LCD			24 VAC
	Backlight LCD			90-260 VAC
	LED	PNP/NPN/Voltage	2 · 1 x 5 A (Changeover) + · 1 x 30 mA (SSR)	10-30 VDC
	LED			24 VAC
	LED			90-260 VAC
 <b>Multifunction 3*</b> (Double Preset Multi-Totalizer Chronometer Ratemeter Batch Counter)	Backlight LCD	PNP/NPN/Voltage	4 · 1 x 5 A (Changeover) + · 1 x 5 A (N/O) + · 2 x 30 mA (SSR)	10-30 VDC
	Backlight LCD			24 VAC
	Backlight LCD			90-260 VAC
	LED	PNP/NPN/Voltage	4 · 1 x 5 A (Changeover) + · 1 x 5 A (N/O) + · 2 x 30 mA (SSR)	10-30 VDC
	LED			90-260 VAC

Size	Digits	Fixing	Designation	Part Number
24 x 48 mm	7 Digits	Clip	CTR24	87 622 161
				87 622 162
				87 622 170
				87 622 190
24 x 48 mm	8 Digits	Clip	CTR24	87 622 061
				87 622 062
				87 622 070
				87 622 081
				87 622 090
24 x 48 mm	7 Digits	Clip	CTR24L	87 623 572
	8 Digits			87 623 573
24 x 48 mm	6 Digits	Clip	CTR24L	87 623 570
48 x 48 mm	6 Digits	Clip	CTR48E	87 629 111
				87 629 114
48 x 48 mm	6 Digits	Clip	CTR48	87 621 111
				87 621 112
				87 621 115
				87 621 211
				87 621 212
				87 621 215
48 x 48 mm	6 Digits	Clip	CTR48	87 621 121
				87 621 122
				87 621 125
				87 621 221
				87 621 225

# Selection Guide - Counters





## ELECTROMECHANICAL

Type	Visualization	Input	Output	Power Supply
 Hour Counter	Mechanical Dial	-	-	4.5-35 VDC
 Hour Counter	Mechanical Dial	-	-	10-30 VDC 20-30 VAC (50 Hz) 187-264 VAC (50 Hz)
 Hour Counter	Mechanical Dial	-	-	10-30 VDC 20-30 VAC (50 Hz) 100-130 VAC (50 Hz) 100-130 VAC (50 Hz) 187-264 VAC (50 Hz) 187-264 VAC (60 Hz)
 Hour Counter	Mechanical Dial	-	-	10-30 VDC 24 VAC (50 Hz) 230 VAC (50 Hz)
 Totalizer	Mechanical Dial	-	-	24 VDC 24 VAC
 Totalizer	Mechanical Dial	-	-	12 VDC 24 VDC 24 VDC 24 VAC 24 VAC 110 VDC 115 VAC 230 VAC 230 VAC

	Size	Digits	Fixing	Designation	Part Number
	15 x 32 mm	7 Digits	Clip	CHM15	99 792 810
	24 x 48 mm	7 Digits	Clip	CHM24	99 782 810 99 782 710 99 782 714
	48 x 48 mm	8 Digits	Clip	CHM48	99 772 810 99 772 710 99 772 712 99 772 715 99 772 714 99 772 716
		7 Digits			
		5 Digits			
		6 Digits			
	35 mm	7 Digits	DIN Rail	CHMDR	99 793 810 99 793 710 99 793 714
	15 x 32 mm	7 Digits	Clip	CIM15	99 778 810 99 778 710
	24 x 48 mm	6 Digits	Clip	CIM24	99 777 815 99 777 810 99 776 907 99 777 710 99 776 904 99 776 905 99 776 902 99 777 714 99 776 901
			Screw		
			Clip		
			Screw		
			Screw		
			Screw		
			Screw		
			Clip		
	Screw				



# Selection Guide - Counters

## ELECTROMECHANICAL

Type	Visualization	Input	Output	Power Supply
 Totalizer	Mechanical Dial	-	-	110 VDC 115 VAC 230 VAC
 Totalizer	Mechanical Dial	-	-	24 VDC 48 VDC 110 VDC 230 VAC
 Totalizer (+ Reset)	Mechanical Dial	-	-	24 VDC 24 VDC 24 VAC 24 VAC 115 VAC 230 VAC 230 VAC
 Totalizer (+ Reset)	Mechanical Dial	-	-	24 VDC 230 VAC
 Totalizer (+ Reset)	Mechanical Dial	-	-	24 VDC 24 VAC 115 VAC 230 VAC
 Totalizer Hour Counter	Mechanical Dial	-	-	10-30 VDC 20-30 VAC (50 Hz) 100-130 VAC (50 Hz) 187-264 VAC (50 Hz)

Size	Digits	Fixing	Designation	Part Number
36 x 37 mm	6 Digits	Screw	CIM36X37	99 776 605
				99 776 602
				99 776 601
36 x 48 mm	6 Digits	Screw	CIM36X48	99 776 707
				99 776 736
				99 776 705
				99 776 701
				99 776 701
24 x 48 mm	5 Digits	Clip	CIM24	99 777 820
		Screw		99 776 927
		Clip		99 777 720
		Screw		99 776 924
		Screw		99 776 922
		Clip		99 777 724
		Screw		99 776 921
36 x 37 mm	5 Digits	Screw	CIM36X37	99 776 616
				99 776 610
36 x 48 mm	5 Digits	Screw	CIM36X48	99 776 716
				99 776 713
				99 776 711
				99 776 710
48 x 48 mm	1 x 7 Digits + 1 x 8 Digits	Clip	CMM48	99 779 810
	2 x 7 Digits			99 779 710
				99 779 712
				99 779 714

## PNEUMATIC COUNTERS

Type	Function	Information
 Totalizer	Mechanical Dial	See page 26 - 92
 Totalizer (+ Reset)		

# Selection Guide - SSR

## Crouzet's Solid State Relays



A series of multipurpose Solid State Relays, in both panel mount, DIN Rail mount and PCB mount. To switch DC loads from 4 to 40 A / 5 to 200 VDC, and switch AC loads from 4 A to 125 A / 24 to 660 VAC.

### AC VOLTAGE SINGLE PHASE







Type	Output		Input	Certifications
	Current	Voltage	Voltage	
 <b>GNA</b> Essential Version	25 A	24-280 VAC	4-32 VDC	cRUus, CE
	40 A	48-660 VAC		
	50 A			
	90 A			
 <b>GN</b> Classic Version	10 A	24-280 VAC	4-32 VDC	cRUus, CE, VDE
	10 A		20-265 VAC	cRUus, CE
	25 A	24-280 VAC	4-32 VDC	cRUus, CE
	25 A		18-36V AC/DC	
	25 A		20-265 VAC	
	25 A	48-660 VAC	4-32 VDC	cRUus, CE, VDE
	25 A		20-265 VAC	cRUus, CE
	50 A		4-32 VDC	cRUus, CE, VDE
	50 A		18-36V AC/DC	cRUus, CE
	50 A	20-265 VAC		
	75 A	48-660 VAC	4-32 VDC	cRUus, CE, VDE
	75 A		20-265 VAC	cRUus, CE
	100 A	48-660 VAC	4-32 VDC	cRUus, CE, VDE
	100 A		20-265 VAC	cRUus, CE
	125 A	48-660 VAC	4-32 VDC	cRUus, CE, VDE
	125 A		20-265 VAC	cRUus, CE
 <b>GN+</b> Performance Version	25 A	12-270 VAC	4-32 VDC	cRUus, CE, VDE
	25 A		20-260 VAC/DC	
	50 A	24-500 VAC	4-32 VDC	cRUus, CE, VDE
	50 A		20-260 VAC/DC	
	90 A	24-500 VAC	4-32 VDC	cRUus, CE, VDE
	90 A		20-260 VAC/DC	
	125 A	24-500 VAC	4-32 VDC	cRUus, CE, VDE
	125 A		20-260 VAC/DC	



## Solid State Relays Features

- Removable covers and output protection included
- Smart load diagnostic versions
- Resistive, Inductive and Capacitive loads



	Mounting	Switching	Usage (Load Type)	Comments	Designation	Part Number
	Panel Mount "Hockey Puck"	Zero Cross	<b>Resistive Loads:</b> • Heating	• To use in simple applications	GNA25DZL	84137910N
					GNA40DZH	84137450N
					GNA50DZH	84137460N
					GNA90DZH	84137480N
	Panel Mount "Hockey Puck"	Zero Cross	<b>Resistive Loads:</b> • Heating • Lighting	• Output Protection Included (TVS)	GN10DZL	84137000N
					GN10AZL	84137001N
					GN25DZL	84137010N
					GN25CZL	84137012N
					GN25AZL	84137011N
					GN25DZH	84137110N
					GN25AZH	84137111N
					GN50DZH	84137120N
					GN50CZH	84137122N
					GN50AZH	84137121N
					GN75DZH	84137130N
					GN75AZH	84137131N
					GN100DZH	84137140N
					GN100AZH	84137141N
GN125DZH	84137180N					
GN125AZH	84137181N					
	Panel Mount "Hockey Puck"	Random (Instantaneous)	<b>Inductive Loads:</b> • Motion • Miscellaneous (high inductive loads, very strong magnetising currents, overvoltages)	• Output Protection Included (RC Snubber)	GN25DRL	84137210N
					GN25ARL	84137211N
					GN50DRL	84137320N
					GN50ARH	84137321N
					GN75DRH	84137330N
	Panel Mount "Hockey Puck"	Special Zero Cross	<b>Resistive Loads:</b> • Heating • Lighting <b>Inductive Loads:</b> • Motion • Miscellaneous (High inductive loads) <b>Capacitive Loads:</b> • Miscellaneous (Strong inrush current)	• Output Protection Included (VDR) • High Immunity (Level A) • Thermal Pad Included	GNP25DZL	84138010N
					GNP25UZL	84138013N
					GNP50DZM	84138120N
					GNP50UZM	84138123N
					GNP90DZM	84138150N
					GNP90UZM	84138153N
					GNP125DZM	84138180N
					GNP125UZM	84138183N

AC VOLTAGE SINGLE PHASE

Type	Output		Input Voltage	Certifications
	Current	Voltage		
 <b>GNR</b> Classic Version	20 A	24-280 VAC	4-32 VDC	cRUus, CE
	20 A	48-660 VAC	4-32 VDC	
	20 A		80-140 VAC	
	20 A		180-280 VAC	
	30 A	48-660 VAC	4-32 VDC	
	30 A		80-140 VAC	
	30 A		180-280 VAC	
	30 A	24-500 VAC	4-32 VDC	cRUus, CE, VDE
 <b>GNR+</b> Performance Version	30 A	24-500 VAC	4-32 VDC	cRUus, CE, VDE
	30 A		180-280 VAC	
	32 A		4-32 VDC	
	45 A		4-32 VDC	cRUus, CE
 <b>GNF</b> Specialized Version	25 A	24-280 VAC	4-30 VDC	cRUus, CE, UKCA
 <b>GN MINI</b> Specialized Version	20 A	24-280 VAC	4-30 VDC	cRUus, CE, UKCA
 <b>GNZ</b> Specialized Version	8 A	24-280 VAC	4-32 VDC	cRUus, CE, UKCA
			4-30 VDC	
 <b>GN Board</b> Classic Version <span style="color: blue; font-weight: bold;">NEW</span>	4 A	12-275 VAC	4-30 VDC	cRUus, CE, UKCA
		12-460 VAC		
	4 A	24-600 VAC	4-10 VDC	cRUus, CE, UKCA
 <b>GNR Mini</b> Classic Version <span style="color: blue; font-weight: bold;">NEW</span>	4 A	12-275 VAC	6-30 VDC	CE, UKCA
		12-460 VAC	12-30 VAC / 8,5-30 VDC	

	Mounting	Switching	Usage (Load Type)	Comments	Designation	Part Number
 DIN Rail 22.5 mm	DIN Rail 22.5 mm	Zero Cross	<b>Resistive Loads:</b> • Heating • Lighting	• Output Protection Included	GNR20DCZL	GNR20DCZL
					GNR20DCZH	GNR20DCZH
					GNR20BCZH	GNR20BCZH
					GNR20ACZH	GNR20ACZH
					GNR30DCZH	GNR30DCZH
					GNR30BCZH	GNR30BCZH
					GNR30ACZH	GNR30ACZH
					 DIN Rail 22.5 mm	DIN Rail 22.5 mm
 DIN Rail 22.5 mm	DIN Rail 22.5 mm	Zero Cross	<b>Resistive Loads:</b> • Heating • Lighting <b>Inductive Loads:</b> • Motion • Miscellaneous (High inductive loads) <b>Capacitive Loads:</b> • Miscellaneous (Strong inrush current)	• Output Protection Included (VDR) • High Immunity (Level A)	GNR30DCZP	GNR30DCZP
					GNR30ACZP	GNR30ACZP
					GNR32DCZP	GNR32DCZP
					GNR45DCZP	GNR45DCZP
 Panel Mount "Hockey Puck"	Panel Mount "Hockey Puck"	Zero Cross	<b>Resistive Loads:</b> • Heating • Lighting	• Output Protection Included (VDR) • FAST-ON terminals	GN20DFZL	84134017N
 Panel Mount "Mini Puck"	Panel Mount "Mini Puck"	Zero Cross	<b>Resistive Loads:</b> • Heating • Lighting	• Output Protection Included (VDR) • FAST-ON terminals	GNM20DFZL	84132010N
 Panel Mount "Low profile"	Panel Mount "Low profile"	Zero Cross	<b>Resistive Loads:</b> • Heating • Lighting <b>Inductive Loads:</b> • Motion • Miscellaneous	• Output Protection Included (VDR) • FAST-ON terminals	GNZ8DFZL	84132210N
		Random			GNZ8DFRL	84132110N
 PCB Mount	PCB Mount	Special Zero Cross	<b>Resistive Loads:</b> • Heating • Lighting <b>Inductive Loads:</b> • Miscellaneous (High inductive loads) <b>Capacitive Loads:</b> • Miscellaneous (Strong inrush current)	• Output Protection Included (TVS)	GNB4D2A	GNB4D2A
					GNB4D2B	GNB4D2B
					GNB4D1C	GNB4D1C
 DIN Rail	DIN Rail	Special Zero Cross	<b>Resistive Loads:</b> • Heating • Lighting <b>Inductive Loads:</b> • Miscellaneous (High inductive loads)	• Output Protection Included (VDR)	GNRM4D2A	GNRM4D2A
					GNRM4B1B	GNRM4B1B

### AC VOLTAGE MULTICHANNEL

Type	Output		Input	Certifications
	Current	Voltage	Voltage	
 <b>GN2/GN2F</b> 2-Channel	25 A	24-280 VAC	10-30 VDC	cRUus, CE, UKCA
	25 A		4-32 VDC	
	50 A	48-660 VAC	4-32 VDC	
	50 A	48-660 VAC	10-30 VDC	
	50 A	24-510 VAC	10-30 VDC	
 <b>GN4</b> 4-Channel	25 A	12-280 VAC	4-32 VDC	cRUus, CE, UKCA



	Mounting	Switching	Usage (Load Type)	Comments	Designation	Part Number
Panel Mount "Hockey Puck"		Zero Cross	<b>Resistive Loads:</b> • Heating • Lighting	• Two SSRs in One package	GN225DZL	84140013N
				• Fast-ON terminals	GN225DFZL	84140800N
		Zero Cross	<b>Resistive Loads:</b> • Heating • Lighting	• Two SSRs in One package	GN250DZL	84140603N
				GN250DZH	84140613N	
Random	<b>Inductive Loads:</b> • Motion • Miscellaneous	GN250DRH	84140631N			
Panel Mount "Hockey Puck"		Special Zero Cross	<b>Resistive Loads:</b> • Heating • Lighting <b>Inductive Loads:</b> • Motion • Miscellaneous <b>Capacitive Loads:</b> • Miscellaneous	• Four SSRs in one package	GN425DFZL	84154010N

### AC VOLTAGE THREE PHASE





Type	Output		Input	Certifications
	Current	Voltage	Voltage	
 <b>GN3</b> Classic Version	25 A	24-510 VAC	4-32 VDC	cRUus, CE, UKCA
	25 A			
	25 A	24-510 VAC	24-255 V AC/DC	
	50 A	24-510 VAC	4-32 VDC	
	50 A			
	50 A	24-510 VAC	24-255 V AC/DC	

	Mounting	Switching	Usage (Load Type)	Comments	Designation	Part Number
Panel Mount "Hockey Puck"		Zero Cross	<b>Resistive Loads:</b> • Heating • Lighting	• Output Protection Included (TVS)	GN325DSZH	GN325DSZH
					Random	<b>Inductive Loads:</b> • Motion • Miscellaneous
		Special Zero Cross	<b>Resistive Loads:</b> • Heating • Lighting <b>Inductive Loads:</b> • Motion • Miscellaneous (High inductive loads) <b>Capacitive Loads:</b> • Miscellaneous (strong inrush current)	• Output Protection Included (TVS)	GN325ASZH	GN325ASZH
					Zero Cross	<b>Resistive Loads:</b> • Heating • Lighting
		Special Zero Cross	<b>Resistive Loads:</b> • Heating • Lighting <b>Inductive Loads:</b> • Motion • Miscellaneous (High inductive loads) <b>Capacitive Loads:</b> • Miscellaneous (Strong inrush current)	• Output Protection Included (TVS)	GN350ASZH	GN350ASZH
					Random	<b>Inductive Loads:</b> • Motion • Miscellaneous

### AC VOLTAGE THREE PHASE

Type	Output		Input	Certifications
	Current	Voltage	Voltage	
 <b>GNR3</b> Classic Version	25 A	24-660 VAC	4-32 VDC	cRUus, CE, UKCA
	25 A	24-660 VAC	24-255 V AC/DC	
 <b>GNO</b> Reverse Version	25 A	24-510 VAC	12-30 VDC	cRUus, CE, UKCA
	50 A			



### DC VOLTAGE



Type	Output		Input	Certifications
	Current	Voltage	Voltage	
 <b>GNAD</b> Essential Version	10 A	5-200 VDC	4-32 VDC	cRUus, CE
	20 A	5-100 VDC		
	40 A	5-55 VDC		
 <b>GND</b> Classic Version	10 A	5-200 VDC	4-32 VDC	cRUus, CE
	40 A	5-60 VDC		
 <b>GND Board</b> Classic Version <b>NEW</b>	4 A	2-60 VDC	4-30 VDC	CE, UKCA
	10 A	7-36 VDC	4-10 VDC	
			10-30 VDC	
 <b>GNRD MINI</b> Specialized Version <b>NEW</b>	4 A	2-60 VDC	5-30 VDC	CE, UKCA
			90-240 VAC/DC	
 <b>GNRD-0</b> Specialized Version <b>NEW</b>	6 A	7-36 VDC	7-30 VDC	CE, UKCA

	Mounting	Switching	Usage (Load Type)	Comments	Designation	Part Number
	DIN Rail 90 mm	Zero Cross	<b>Resistive Loads:</b> • Heating • Lighting	• Output Protection Included (TVS)	GNR325DCZH	GNR325DCZH
		Special Zero Cross	<b>Resistive Loads:</b> • Heating • Lighting <b>Inductive Loads:</b> • Motion • Miscellaneous (High inductive loads) <b>Capacitive Loads:</b> • Miscellaneous (strong inrush current)		GNR325ACZH	GNR325ACZH
	Panel Mount "Hockey Puck"	Special Zero Cross	<b>Resistive Loads:</b> • Heating • Lighting <b>Inductive Loads:</b> • Motion • Miscellaneous (High inductive loads) <b>Capacitive Loads:</b> • Miscellaneous (strong inrush current)	• Output Protection Included (RC, VDR) • Start/Stop/Reverse in the same product	GNO25DSRL	GNO25DSRL
					GNO50DSRL	GNO50DSRL



	Mounting	Switching	Usage (Load Type)	Comments	Designation	Part Number
	Panel Mount "Hockey Puck"	DC Switching	<b>DC Loads:</b> • Heating • Motion • Lighting • Miscellaneous	• To use in simple applications	GNAD10DH	84137650N
					GNAD20DM	84137660N
					GNAD40DL	84137670N
	Panel Mount "Hockey Puck"	DC Switching	<b>DC Loads:</b> • Heating • Motion • Lighting • Miscellaneous	• Output Protection Included (TVS*)	GND10DH	84137850N
					GND40DM	84137870N
	PCB Mount	DC Switching	<b>DC Loads:</b> • Heating • Motion • Lighting • Miscellaneous	-	GND4D2D	GND4D2D
					GND10D1E	GND10D1E
					GND10B1E	GND10B1E
	DIN Rail	DC Switching	<b>DC Loads:</b> • Lighting • Miscellaneous	• Output Protection Included (TVS)	GNRDM4D1C	GNRDM4D1C
					GNRDM4A1C	GNRDM4A1C
	DIN Rail	DC Switching	<b>DC Loads:</b> • Motion	• Output Protection Included (TVS)	GNRD06CDL	GNRD06CDL

### Load Diagnostic: Smart SSR





Type	Output		Input	Certifications
	Current	Voltage	Voltage	
 <b>GN Smart</b> Load Detection	50 A	24-600 VAC	4-32 VDC	cRUus, CE, VDE
	35 A	50-265 VAC	8-30 VDC	
	50 A	150-510 VAC		
	75 A			
 <b>GNR Smart Module</b> Load Detection	40 A	-	4-32 VDC	CE
	40 A		24-45 VDC	

	Mounting	Switching	Usage (Load Type)	Comments	Designation	Part Number
 Panel Mount "Hockey Puck"		Zero Cross	Current Detection	-	GNS50DAZH	84136120N
		Zero Cross	Load Detection	-	GNS35DDZH	84139150N
						GNS50DDZH
		GNS75DDZH				84139130N
 Module On GNR/GNR+		-	Current Detection	-	GNS40DDDR	84050040N
			Current & Diagnostic		GNS40FDDR	84050043N

### ACCESSORIES

Type	Description	P/N
 <b>Heatsinks</b> For Panel Mount SSRs	0.9 °C/W Thermal Resistance	26532752N
	1.1 °C/W Thermal Resistance	26532753N
	1.2 °C/W Thermal Resistance	26532754N
	1.75 °C/W Thermal Resistance	26532755N
	2.2 °C/W Thermal Resistance	26532756N
	Heatsink screw mounting kit, for SSRs with Hockey Puck shape	26532001
	Heatsink screw mounting kit, for 3-phase SSRs	26532002
 <b>Adapters</b> For DIN Rail	DIN Rail Adaptor for SSRs with Hockey Puck shape	26532764N
 <b>Thermal Pads</b> For Heatsink Mounting	Pre-cut thermal pad	26532720N
	Self-adhesive thermal pad	26532722N

### ACCESSORIES

Type	Description	P/N
 <b>Screws</b> For Heatsink Mounting	Screw Mounting Kit for Single & Dual-Phase SSR	26532001
	Screw Mounting Kit for 3-Phase SSR	26532002
 <b>Thermal Grease</b> For Heatsink Mounting	Thermal Grease	26532003
 <b>Label</b> For SSR identification	Label for SSR Identification	26532004
 <b>Connectors</b>	GN2, 4-Pin, 4 pole 90° & 270° set-screw connector	26532005
	GN2, 4-Pin, 4 pole 270° set-screw connector	26532006



# Automation Controllers Selection Guide

	Simple & small applications	Simple standalone applications	Connectivity needed	High-end & niche applications	Remote applications	
	<p>Slim Logic Controller</p> <p><i>Millenium Slim</i></p>	<p>Logic Controller</p> <p><i>Millenium 3</i></p>	<p>Communicating Logic Controller</p> <p><i>Millenium Exo</i></p>	<p>Nano-PLC</p> <p><i>em4 NANOPLC</i></p>	<p>Telecontroller</p> <p><i>em4 ALERT</i></p>	
INPUTS & OUTPUTS	Memory Capacity	1000 FB	500 FB	1000 FB	2000 FB	
	Number of I/Os	8	Up to 50	Up to 44	Up to 46	
	Analog Inputs (CPU)	4	6	8	12	12
	4-20mA Inputs (CPU)	N/A	N/A	N/A	4	4
	High-Speed Digital Inputs	15 KHz	6 KHz	15 KHz	60 KHz	60 KHz
COMMUNICATION	Ethernet Embedded	NO	NO	YES	YES	N/A
	Modbus Interface	N/A	N/A	SERVER	CLIENT/SERVER	CLIENT/SERVER
	Bluetooth Communication	YES	N/A	YES	YES	YES
	Mobile Communication (3G)	N/A	N/A	N/A	N/A	YES
	Datalog Number of Values	8 VALUES	N/A	16 VALUES	24 VALUES	24 VALUES
	Event Number of Values	N/A	N/A	12 VALUES	24 VALUES	24 VALUES
		CROUZET SOFT (FBD-SFC)	MILLENIUM SOFT (LD-FBD-SFC)	CROUZET SOFT (FBD-SFC)		

LD: Ladder  
 FBD: Function Block Diagram  
 SFC: Sequential Function Chart

CROUZET Virtual Display is compatible with Slim, Millenium EVO, em4 and em4 Alert

# Selection Guide - Automation

## Crouzet's Automation Controllers

Automation for everyone! Easy to use and powerful Automation Controllers, adaptable for all kinds of projects - from the simplest to complex applications. Crouzet's Automation Controllers offer free software and are easy and intuitive to use, even for programming novices.







### SLIM LOGIC CONTROLLER – MILLENIUM SLIM

*MilleniumSlim*, The smallest logic controller ever! For all your standalone small-scale applications

Type	Total I/Os	Convertible Inputs				Output Types	
		Digital	Analog	PWM	High-Speed	Digital	PWM
 <b>Slim Controller Kit</b>	<b>8 I/Os</b> · 4 Inputs · 4 Outputs	<b>4</b> · Classical Digital	-	-	-	<b>4</b> · 6A Relay	-
			<b>4</b> · 0-10 VDC or 0-VCC	<b>2</b> · 10 Hz to 1 KHz	<b>2</b> · 5 KHz	<b>4</b> · 6A Relay	-
			-	-	-	<b>4</b> · 0.5A Static	-

### LOGIC CONTROLLER - MILLENIUM 3

Millenium 3, the logic controller of choice for 10+ years

Type	Total I/Os	Convertible Inputs		Output Types		
		To Digital	To Analog	Digital	PWM	Analog
 <b>Non-Expandable Short - With Screen</b>	<b>12 I/Os</b> · 8 Inputs · 4 Outputs	8	4	4 Relay	-	-
				4 Static	1	
				4 Relay	-	
 <b>Non-Expandable Short - No Screen</b>	<b>12 I/Os</b> · 8 Inputs · 4 Outputs	8	4	4 Relay	-	-
				4 Static	1	
 <b>Starter Kit Short - With Screen</b>	<b>12 I/Os</b> · 8 Inputs · 4 Outputs	8	4	4 Relay	-	-
 <b>Expandable Short - With Screen</b>				4 Relay	-	
 <b>Expandable Long - With Screen</b>	<b>26 I/Os</b> · 16 Inputs · 10 Outputs	16	6	10 Relay	-	-
				10 Static	4	
				10 Relay	-	
 <b>Expansion Short - Digital</b>	<b>6 I/Os</b> · 4 Inputs · 2 Outputs	4	-	2 Relay	-	-
 <b>Expansion Long - Digital</b>				4 Relay	-	

More versions available at [www.crouzet.com](http://www.crouzet.com)

## Automation Controller Features

- Graphic Programming language (FBD) and several ways of communication (3G, Ethernet, Modbus...)
- Many Options: 10-12 I/Os, 24-26 I/Os, Expandable. Digital/Analog Inputs. Relay/PWM outputs, etc.
- DesignLab for custom adaptations, 100+ years of Engineering expertise at your service

	Embeddded Communication	Embeddded Screen	Power Supply	Comments	Designation	Part Number
Bluetooth	Virtual only		110-240 VAC	<ul style="list-style-type: none"> <li>• 17.5 mm body</li> <li>• DIN Rail &amp; panel mount</li> <li>• Bluetooth programming</li> </ul>	CB8R (AC)	88 983 903*
			24 VDC		CB8R (DC)	88 983 901*
			24 VDC		CB8S (DC)	88 9839 02*









\* **88 983 903** (kit: 88 983 003 + connectors) - \* **88 983 901** (kit: 88 983 001 + connectors) - \* **88 983 902** (kit: 88 983 002+ connectors)

	Embeddded Communication	Embeddded Screen	Power Supply	Comments	Designation	Part Number
-	-	✓	12 VDC	-	CD12	88 974 045
			24 VDC			88 974 046
			100-240 VAC			88 974 041
			24 VDC			88 974 042
			100-240 VAC			88 974 043
-	-	-	24 VDC	-	CB12	88 974 021
			100-240 VAC			88 974 023
-	-	✓	24 VDC	CD12, Programming Cable, CD with Software	CD12 Starter Kit	88 974 080
			100-240 VAC			88 974 081
			24 VDC			More I/Os are possible by adding an expansion
100-240 VAC	88 974 142					
-	-	✓	12 VDC	More I/Os are possible by adding an expansion	XD26	88 974 143
			24 VDC			88 974 165
			24 VDC			88 974 161
			100-240 VAC			88 974 162
-	-	-	24 VDC	-	XR06	88 974 163
			100-240 VAC			88 970 211
-	-	-	24 VDC	-	XR10	88 970 213
			100-240 VAC			88 970 221
-	-	-	24 VDC	-	XR10	88 970 221
			100-240 VAC			88 970 223

# Selection Guide - Automation





## COMMUNICATING LOGIC CONTROLLER - MILLENIUM EVO



Millenium EVO, the logic controller of choice for all your projects requiring communication

Type	Total I/Os	Convertible Inputs		Output Types		
		To Digital	To Analog	Digital	PWM	Analog
 <b>Screen Option</b> Local / Standalone	<b>24</b> · 16 Inputs · 8 Outputs	<b>16</b> · 12 to Classical Digital · 4 to Classical Digital or 15 KHz High-Speed	<b>8</b> · To 0-10 VDC or 0-VCC	<b>8</b> · 6 x 8 A · 2 x 6 A	-	-
 <b>Blind Option</b> Local / Standalone						
 <b>Starter Kit</b> Local / Standalone						
 <b>Screen Option</b> Ethernet Version	<b>24</b> · 16 Inputs · 8 Outputs	<b>16</b> · 12 to Classical Digital · 4 to Classical Digital or 15 KHz High-Speed	<b>8</b> · To 0-10 VDC or 0-VCC	<b>8</b> · 6 x 8 A · 2 x 6 A	-	-
 <b>Blind Option</b> Ethernet Version						
 <b>Starter Kit</b> Ethernet Version						
 <b>Expansion</b> Digital	<b>10</b> · 6 Inputs · 4 Outputs	<b>6</b> · Classical Digital	-	<b>4</b> · 2 x 8 A · 2 x 6 A	-	-
 <b>Expansion</b> Analog			<b>4</b> · 0-10 VDC or 4 to 20 mA	<b>2</b> · 0.5 A Static		

	Embedded Communication	Embedded Screen	Power Supply	Comments	Designation	Part Number
		✓	24 VDC	-	XDP24	88 975 101
	-	-		-	XBP24	88 975 001
		✓		Millenium EVO + Bluetooth Interface + Bluetooth Receiver	XDP24 Starter Kit	88 975 901
	Ethernet TCP/IP	✓	24 VDC	Embedded Ethernet Communication	XDP24-E	88 975 111
		-		Embedded Ethernet Communication	XBP24-E	88 975 011
		✓		Millenium EVO + Bluetooth Interface + Bluetooth Receiver	XDP24-E Starter Kit	88 975 911
	-	-	24 VDC	To control power actuators (valves, pumps...)	XRP10	88 975 201
				To control analog actuators (controlled valve, controlled pump...)	XAPI0	88 975 303

## ACCESSORIES







Type	Compatibility	Description	P/N
 <b>USB Dongle</b>	· Slim · Millenium 3	Bluetooth, CE, FCC and IC certified	88 980 124
 <b>Prog Cable</b> Via USB	· Millenium 3: Logic Controller	USB Programming Cable	88 970 109
 <b>Memory Cartridge</b> Memory Storage	· Millenium 3: Logic Controller	Memory Cartridge	88 970 108
 <b>Connectors</b> Pluggable	· Millenium 3: Logic Controller	For 12 I/Os version	88 970 310
		For 20 I/Os version	88 970 311
		For 26 I/Os version	88 970 312

Type	Compatibility	Description	P/N
 <b>Interfaces</b> For USB, Modbus or Bluetooth Communication	· em4: Nano-PLC · em4 Alert: Telecontroller · Millenium EVO: Communicating Logic Controller	USB programming	88 980 110
		Modbus - Polarization	88 980 123
		Modbus - No Polarization	88 980 122
		Bluetooth	88 980 112
		Bluetooth + PC Dongle	88 980 116
 <b>Antenna</b> For Cellular Network Communication	· em4 Alert: Telecontroller	Antenna 3M	88 980 160

# Selection Guide - Automation





## NANO-PLC - EM4

The PLC made simple, PLC performance with logic controller simplicity, for high-end applications

Type	Total I/Os	Convertible Inputs		Output Types		
		To Digital	To Analog	Digital	PWM	Analog
 <b>Nano-PLC</b> Local / Standalone	<b>26</b> · 16 Inputs · 10 Outputs	<b>16</b> · 12 to Classical Digital · 4 to Classical Digital or 60 KHz High-Speed	<b>12</b> · 8 to 0-10 VDC or 0-VCC · 4 to 20 mA or 0-10 VDC	<b>8</b> · 6 x 8 A · 2 x 6 A	<b>2</b> · 0.5 A Static	-
 <b>Starter Kit</b> Local / Standalone						
 <b>Nano-PLC</b> Ethernet Version	<b>26</b> · 16 Inputs · 10 Outputs	<b>16</b> · 12 to Classical Digital · 4 to Classical Digital or 60 KHz High-Speed	<b>12</b> · 8 to 0-10 VDC or 0-VCC · 4 to 20 mA or 0-10 VDC	<b>8</b> · 6 x 8 A · 2 x 6 A	<b>2</b> · 0.5 A Static	-
 <b>Starter Kit</b> Ethernet Version						
 <b>Expansion</b> Digital	<b>10</b> · 6 Inputs · 4 Outputs	<b>6</b> · Classical Digital	<b>6</b> · 0-10 VDC or 0 VCC	<b>4</b> · 2 x 8 A · 2 x 6 A	-	-
 <b>Expansion</b> Analog			<b>6</b> · 0-10 VDC or 4 to 20 mA		-	<b>2</b> · 0.5 A Static

## TELECONTROLLER - EM4 ALERT

em4 Alert has a built-in GSM modem to connect to any cellular network to control and monitor

Type	Total I/Os	Convertible Inputs		Output Types		
		To Digital	To Analog	Digital	PWM	Analog
 <b>Telecontroller</b> 3G Version	<b>26</b> · 16 Inputs · 10 Outputs	<b>16</b> · 12 to Classical Digital · 4 to Classical Digital or 60 KHz High-Speed	<b>12</b> · 8 to 0-10 VDC or 0-VCC · 4 to 20 mA or 0-10 VDC	<b>8</b> · 6 x 8 A · 2 x 6 A	<b>2</b> · 0.5 A Static	-
 <b>Starter Kit</b> 3G Version						
 <b>Expansion</b> Digital	<b>10</b> · 6 Inputs · 4 Outputs	<b>6</b> · Classical Digital	<b>6</b> · 0-10 VDC or 0-VCC	<b>4</b> · 2 x 8 A · 2 x 6 A	-	-
 <b>Expansion</b> Analog			<b>6</b> · 0-10 VDC or 4 to 20 mA		-	<b>2</b> · 0.5 A Static

	Embeddded Communication	Embeddded Screen	Power Supply	Comments	Designation	Part Number
	-	✓	24 VDC	To use in local applications	B26	88 981 103
	-	✓	24 VDC	em4 + Software + USB interface + USB cable	B26 Starter Kit	88 981 106
	Ethernet TCP/IP	✓	24 VDC	Embedded Ethernet Communication	B26 ET	88 981 133
	-	-	24 VDC	em4 + Software + Ethernet RJ45 cable	B26 ET Starter Kit	88 981 136
	-	-	24 VDC	To control power actuators (valves, pumps...)	E10R	88 982 113
	-	-	24 VDC	To control analog actuators (controlled valve, controlled pump...)	E10A	88 982 213

	Embeddded Communication	Embeddded Screen	Power Supply	Comments	Designation	Part Number
	3G Cellular Network	✓	24 VDC	Embedded GSM Modem	B26-3GS	88 981 123
	-	-	24 VDC	em4 Alert + Antenna + Software + USB interface + USB cable	B26-3GS Starter Kit	88 981 126
	-	-	24 VDC	To control power actuators (valves, pumps...)	E10R	88 982 113
	-	-	24 VDC	To control analog actuators (controlled valve, controlled pump...)	E10A	88 982 213

# Selection Guide – HMI's

	Essential		Performance		
	CT104	CT107	CPT104N-E	CPT107-E	CPT110N-E
Size	4,3"	7"	4,3"	7"	10,1"
Resolution	480 x 272	800 x 480	480 x 272	800 x 480	1024 x 600
Brightness	400 cd/m <sup>2</sup>	300 cd/m <sup>2</sup>	400 cd/m <sup>2</sup>	400 cd/m <sup>2</sup>	350 cd/m <sup>2</sup>
Processor	A8 - 600 MHz	A8 - 600 MHz	A8 - 600 MHz	A8 - 600 MHz	A8 - GHz
Storage memory	128 MByte	128 MByte	128 MByte	128 MByte	4 GByte
RAM memory	128 MByte	128 MByte	128 MByte	128 MByte	1 GByte
USB	Host USB 2.0	Host USB 2.0	Host USB 2.0	Host USB 2.0	Host USB 2.0
Ethernet	1 RJ45,10/100Mbit/s	1 RJ45,10/100Mbit/s	1 RJ45,10/100Mbit/s	1 RJ45,10/100Mbit/s	2 RJ45,10/100Mbit/s
RS 232	COM 1	COM 1	COM 1	COM 1	COM 1 / COM 3
RS 485	COM 1 / COM 3	COM 2	COM 1	COM 1	COM 2 / COM 3
CAN	N/A	N/A	N/A	N/A	N/A

CRUZET Touch Soft

## CRUZET TOUCH SOFT

### NEW UPGRADE!

Get the newest version of **Crouzet Touch Soft** for free and play around with our most intuitive and well designed user interface yet

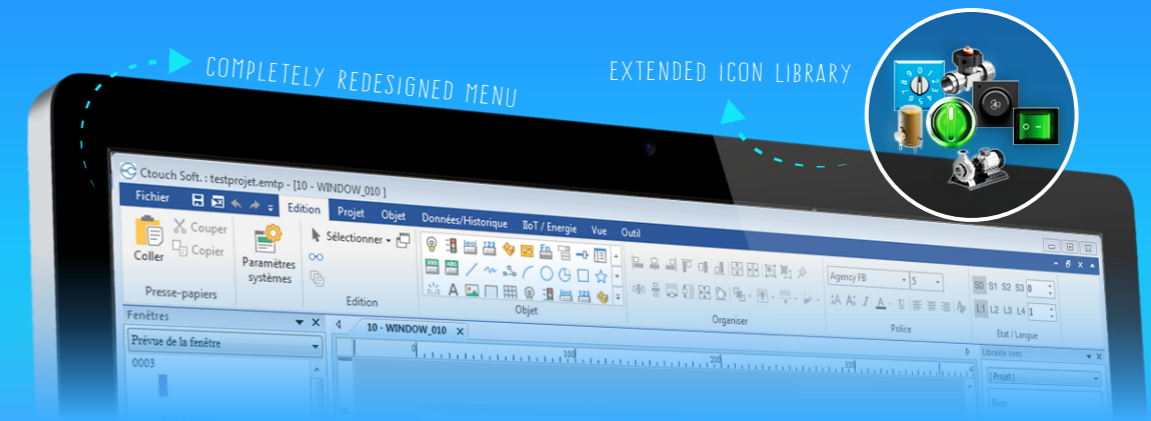

#### IMAGINE AND CONCEIVE YOUR PROJECT IN AN EASY WAY

- Manage all your HMI project from Crouzet Touch Utility Manager
- A wide range of tools to help you develop the perfect project
- Dedicated communication drivers for em4 and Millenium 3 allowing simple addressing and label management
- Import existing MTP HMI programmes into the new Crouzet Touch Soft
- It's available in english, french, italian, german, spanish



#### KEY FEATURES

##### FUNCTION BAR

- > With simple icons

##### ORGANISE YOUR PROJECT

- > Tree and display all object names

##### CUSTOMISE YOUR APPLICATION

- > Create your own library and import pictures

##### ENHANCED SECURITY

- > By creating access levels for users

##### CREATE AND DESIGN

- > Main window makes it easy to create any functional object

##### LABEL TAG

- > Allows use of up to 8 different languages

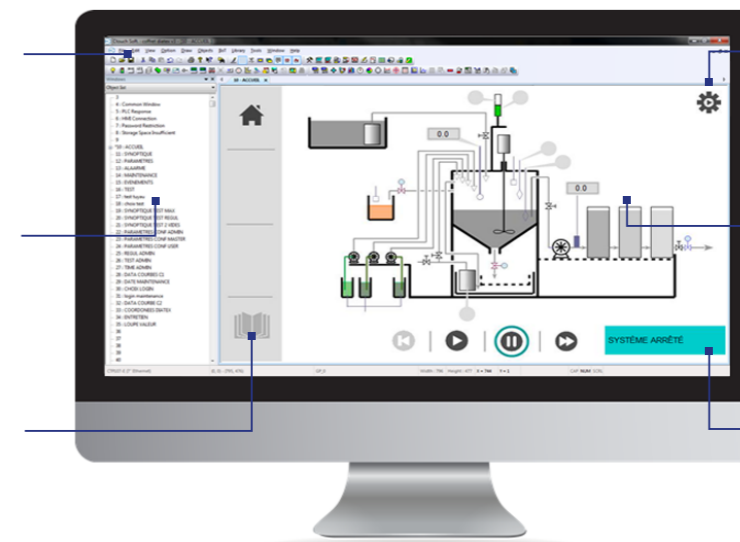

#### ASSOCIATED FEATURES



**EMAIL & CSV**  
Send e-mails with datalog files (csv) from a data sampling and when an event is triggered



**ENHANCED SECURITY**  
Enhanced security mode to manage users and classes easily with dedicated system pages



**EASY DIAGNOSER**  
Analysing and diagnosing communication between HMI and PLC



**PASS THROUGH**  
Allows connection of the PLC to the HMI allowing debugging of the system



**RECIPE IMPORT / EXPORT**  
Creating and managing recipes is much easier using the «recipe view» object and system registers available in Crouzet Touch software



**COMBO BUTTON**  
Execute multiple commands with one button



**EASY SIMULATOR**  
Allows online / offline simulation of your HMI application









**VNC**  
Allows network connection to the HMI via VNC client on PC or mobile phone

# Selection Guide – HMI's





## Crouzet's HMI's

Crouzet HMI's are perfectly suited to be used with the whole range of Crouzet's Automation Controllers, thanks to the several ways of communication, and the pre-configured communication drivers that simplify the configuration.

### PERFORMANCE

Size	Type	Supply	Resolution	ROM	RAM
 <b>4 inch</b> HMI	<b>Touch Screen</b> HMI only	24 VDC	480x272	128 Mbyte	128 Mbyte
 <b>4 inch</b> Kits	<b>Cable Kit</b> HMI + Cable for Controller Millenium3				
	<b>Starter Kit (+Logic Controller M3)</b> HMI + Controller Millenium3 XD10R + Cable				
	<b>Starter Kit (+Logic Controller MEVO)</b> HMI + Controller Millenium EVO XDP24-E + Cable				
 <b>7 inch</b> HMI	<b>Touch Screen</b> HMI Only	24 VDC	800x480	128 Mbyte	128 Mbyte
 <b>7 inch</b> Kits	<b>Cable Kit</b> HMI + Cable for Controller Millenium3				
	<b>Starter Kit (+Logic Controller M3)</b> HMI + Controller Millenium3 XD26R + Cable				
	<b>Starter Kit (+Logic Controller MEVO)</b> HMI + Controller Millenium EVO XDP24-E + Cable				
	<b>Starter Kit (+Nano-PLC em4)</b> HMI + Controller em4 Ethernet + Cable				
 <b>10.1 inch</b> HMI	<b>Touch Screen</b> HMI Only	24 VDC	1024x600	4 Gbyte	1 Gbyte
 <b>10.1 inch</b> Kits	<b>Cable Kit</b> HMI + Cable for Controller Millenium3				
	<b>Starter Kit (+Nano-PLC em4)</b> HMI + Controller em4 Ethernet + Cable				

### ESSENTIAL

Size	Type	Supply	Resolution	ROM	RAM
 <b>4 inch</b> HMI	<b>Touch Screen</b> HMI only	24 VDC	480x272	128 Mbyte	128 Mbyte
 <b>4 inch</b> Kit	<b>Cable Kit</b> HMI + Cable for Controller Millenium3				
 <b>7 inch</b> HMI	<b>Touch Screen</b> HMI only	24 VDC	800x480	128 Mbyte	128 Mbyte
 <b>7 inch</b> Kit	<b>Cable Kit</b> HMI + Cable for Controller Millenium3				

## HMI Features





- Easy to use graphic software pre-configured communication drivers
- Many Options: 4.3", 7" and 10", Essential and Performance versions
- Several ways of communication: Ethernet, Modbus, SLin/SLout

Communication	CAN Bus	Designation	Part Number
<ul style="list-style-type: none"> <li>· 1 x Port Ethernet</li> <li>· 1 x Port COM1 RS232</li> <li>· 1 x Port COM2 RS485</li> </ul>	-	CTP104N-E	88 970 554N
		CTP104N-E Cable Kit	88 970 553
		CTP104N-E Starter Kit	88 970 555
		CTP104N-E Starter Kit	88 970 558
<ul style="list-style-type: none"> <li>· 1 x Port Ethernet</li> <li>· 1 x Port COM1 RS232</li> <li>· 1 x Port COM2 RS485</li> </ul>	-	CTP107-E	88 970 564
		CTP107-E Cable Kit	88 970 563
		CTP107-E Starter Kit	88 970 566
		CTP107-E Kit	88 970 568
		CTP107-E Starter Kit	88 970 567
<ul style="list-style-type: none"> <li>· 2 x Ports Ethernet</li> <li>· 1 x Port COM1 RS232</li> <li>· 1 x Port COM2 RS485</li> <li>· 1 x Port COM3 RS232 or RS485</li> </ul>	-	CTP110N -E	88 970 584
		CTP110N-E Cable Kit	88 970 573
		CTP110N -E Kit	88 970 577

Communication	CAN Bus	Designation	Part Number
<ul style="list-style-type: none"> <li>· 1 x Port COM1 RS232 or RS485</li> <li>· 1 x Port COM3 RS485</li> <li>· 1 x Port Ethernet</li> </ul>	-	CT104	88 970 524
		CT104 Cable Kit	88 970 523
<ul style="list-style-type: none"> <li>· 1 x Port COM1 RS232 or RS485</li> <li>· 1 x Port COM3 RS485</li> </ul>	-	CT107	88 970 534
		CT107 Cable Kit	88 970 533

# Selection Guide – HMI's

## Connect an HMI with the controller: **Cables and Expansions/Interfaces Needed**

HMI's		ACCESSORIES FOR CONNECTION VIA <b>MODBUS (RTU)</b>		ACCESSORIES FOR CONNECTION VIA <b>ETHERNET (TCP/IP)</b>		CONTROLLERS		
		Cable	Controller Expansion/Interface	Cable	Controller Expansion/Interface			
4 inch HMI	PERFORMANCE	CTP104N-E	 <b>Modbus Cable</b> 88 980 171	 <b>Modbus Interface</b> 88 980 122 or 88 980 123	 <b>Ethernet cable</b> 88 970 508	 <b>Not Possible</b> (Telecontroller em4 Alert Without Ethernet Communication)	 <b>+ Telecontroller em4 Alert</b>	
		CTP104N-E						 <b>M3 Modbus Cable</b> 88 970 503
		CTP104N-E	 <b>Modbus Cable</b> 88 980 172	 <b>Modbus Interface</b> 88 980 122 or 88 980 123		 <b>No Interface needed</b> (Direct Connection to Controller)		
		CTP104N-E						 <b>M3 Modbus Cable</b> 88 970 504
7 inch & 10 inch HMI's	ESSENTIAL	CTP107-E CTP110N-E	 <b>Modbus Cable</b> 88 980 172	 <b>Modbus Interface</b> 88 980 122 or 88 980 123	 <b>Not Possible</b> (Telecontroller em4 Alert Without Ethernet Communication)	 <b>+ Telecontroller em4 Alert</b>		
		CTP107-E CTP110N-E					 <b>M3 Modbus Cable</b> 88 970 504	 <b>Modbus Expansion XN06</b> 88 972 250
		CTP107-E CTP110N-E	 <b>Modbus Cable</b> 88 980 171	 <b>Modbus Interface</b> 88 980 122 or 88 980 123				
		CTP107-E CTP110N-E					 <b>M3 Modbus Cable</b> 88 970 503	 <b>Modbus Expansion XN06</b> 88 972 250
4 inch & 7 inch HMI's	ESSENTIAL	CT104 CT107	 <b>Modbus Cable</b> 88 980 171	 <b>Modbus Interface</b> 88 980 122 or 88 980 123	 <b>Not Possible</b> (Telecontroller em4 Alert Without Ethernet Communication)	 <b>+ Telecontroller em4 Alert</b>		
		CT104 CT107					 <b>M3 Modbus Cable</b> 88 970 503	 <b>Modbus Expansion XN06</b> 88 972 250
		CT104 CT107	 <b>Modbus Cable</b> 88 980 171	 <b>Modbus Interface</b> 88 980 122 or 88 980 123				
		CT104 CT107					 <b>M3 Modbus Cable</b> 88 970 503	 <b>Modbus Expansion XN06</b> 88 972 250



# Selection Guide – Complementary Products

## Crouzet's Complementary Products

Crouzet offers complementary products such as a high-performance range of power supplies, signal converters, temperature sensors and probes, many adapted especially for use with Crouzet Automation Controllers and Timers

### POWER SUPPLIES

Compact offer of 12 and 24 VDC DIN-Rail Modular & Industrial Power Supplies with high efficiency (up to 90%)

Type	Output Power	Output Voltage	Output Current	Width
 Modular AC to DC	10 W	24 VDC	0.42 A	18 mm
	30 W		1.25 A	36 mm
	60 W		2.5 A	54 mm
	100 W		4.2 A	72 mm
<b>NEW</b>  Industrial AC to DC	60 W	12 VDC	5 A	43 mm
	96 W		8 A	
	216 W		18 A	50 mm
<b>NEW</b>  Industrial AC to DC	60 W	24 VDC	2.5 A	43 mm
	120W		5 A	
	240 W		10 A	50 mm
	480 W		20 A	60 mm



## Features

- Designed for a wide range of industrial and building applications
- Many Options: Power supplies, signal converters, temperature sensors, temperature probes
- Adapted to be used with other Crouzet products

Mounting	Input Voltage	Output	Adjustable Output	Part Number
DIN Rail	100-240 VAC	1	No	89 451 001
		1	Yes 24-28 VDC	89 451 003
		2		89 451 006
		2		89 451 010
DIN Rail	90 VAC → 264 VAC	1	12 – 14 VDC	89 452 061
				89 452 121
				89 452 241
DIN Rail	90 VAC → 264 VAC	1	24 – 28 VDC	89 452 062
				89 452 122
				89 452 242
				89 452 482



### TEMPERATURE & SIGNAL CONVERTERS

Temperature & Signal Converters designed for simple & direct connection to Crouzet's Automation Controllers

Type	Range	Input	Output	Part Number
 Temperature to Voltage	-20 → +150 °C	Pt1000 3-wire	0-10 VAC	88 950 150
	-40 → +40 °C	Pt100 3-wire		88 950 151
	0 → +100 °C			88 950 152
	0 → +250 °C			88 950 153
	0 → +300 °C			Thermocouple J
	0 → +600 °C	Thermocouple K		88 950 155
 Current to Voltage	4 x 0-20 mA		4 x 0-10 VAC	88 950 108
 PWM to Voltage	1 x 24 VDC (120 Hz max)		1 x 0-10 VAC	88 950 112









### FACEPLATES

ed for Crouzet's Automation Controllers

Type	Compatibility	Size	Part Number
 IP40 Protection	10-12 I/Os Controllers	110 x 108 mm	88 970 809
	24-26 I/Os Controllers	155 x 108 mm	88 970 810
 IP67 Protection	10-12 I/Os Controllers	91 x 97.7 mm	89 750 160
	24-26 I/Os Controllers	162 x 97.7 mm	89 750 161
	24-26 I/Os Controllers + Expansions	257.4 x 97.7 mm	89 750 162

### TEMPERATURE SENSORS

Probes designed for simple & direct connection to Crouzet's Automation Controllers

Type	Range	Power Supply	Output	Part Number
 Air Sensor	-10°C +40°C	24 VDC	0 → 10 V / 4-20mA	89 750 190
 Duct Probe	- 10°C +60°C			89 750 191
 External Probe	-10°C + 40°C			89 750 192
 Remote/ Submersible	-10°C + 110°C			89 750 193
 NTC1 (AS Probe)	-25 → +85 °C	-	10 k Ω @ 25 °C	89 750 180
 NTC2 (PVC Probe)	-25 → +85 °C			89 750 174
 NTC2 (POM Probe)	-20 → +105 °C			89 750 185
 NTC2 (Stainless Steel Probe)	-35 → +120 °C			89 750 182
 NTC3 (Silicone Probe)	0 → +180 °C			100 k Ω @ 25 °C

# Selection Guide – Pneumatic Switches & Sensors



## Crouzet's Pneumatic Components

For more than 60 years now, Crouzet has offered a wide range of pneumatic products for simple automation systems using compressed air, without a source of electricity. Suitable for numerous applications, especially in explosive environments (ATEX).

## Pneumatic Components Features









- Suitable for medical equipment, railway applications, packaging machines, industrial machines, etc.
- Many Options: Manually operated switches, logic components, solenoid valves, air pressure sensors...
- DesignLab for tailor-made pneumatic boards, 60+ years of Engineering expertise at your service

### AIR PRESSURE/VACUUM SENSORS (WITH PNEUMATIC OUTPUT)

Type	Output	Adjustment Range	Hysteresis	Accuracy
 Pressure Detection	Positive	50 → 500 mb	320 mb @ 2 → 8 b	4% @ 2 → 8 b
		0.1 → 2.5 b		
	Negative	2 → 8 b		4% @ 2 → 8 b
		50 → 500 mb		
 Vacuum Detection	Positive	0.1 → 2.5 b	80 mb	-
	Negative	2 → 8 b		

Flow at 4 bar	Orifice Diameter	Mounting	Standard P/N	ATEX Compliant P/N
170 NL/min	2.5 mm	Sub-base Mount	81 505 140	81 505 141
			81 505 150	-
			81 505 160	81 505 164
			81 502 140	81 502 141
			81 502 150	-
			81 502 160	-
170 NL/min	-		81 505 110	81 505 111
			81 502 110	-

### AIR PRESSURE/VACUUM SENSORS (WITH ELECTRICAL OUTPUT)



Type	Output	Adjustment Range	Hysteresis	Protection
 Pressure Detection	5A @ 230 V	2 → 8 bar	1 bar @ 6 bar	IP20
 Pressure Detection				IP 54
 Pressure Detection				IP 54
 Pressure Detection		1.4 +/- 0.5 bar	-	IP 54
 Pressure Detection (With manual override)	5A @ 230 V	2 → 8 bar	1 bar @ 6 bar	IP20
 Pressure Detection (With manual override)				IP 54
 Pressure Detection (With manual override)		1.4 +/- 0.5 bar	-	IP 54
 Low Pressure Detection	5A @ 230 V	0.3 → 1.2 bar	Max. 200 mb	IP20

Connection	Mounting	Contact Form	Standard P/N	ATEX Compliant P/N
Push-in connection Ø 4 mm for semi-rigid tubing	DIN Rail Mount	Form C	81 513 502	-
	Sub-base Mount		81 513 516	-
1/8 Inch BSP (British Standard Pipe Thread Size)	Panel Mount (via 2 x M4 Screws)		81 513 533	-
Push-in connection Ø 4 mm for semi-rigid tubing	Sub-base Mount	Form Z	81 509 080	-
	DIN Rail Mount	Form C	81 513 552	81 513 530
	Sub-base Mount		81 513 510	-
		Form Z	81 509 085	-
Push-in connection Ø 4 mm for semi-rigid tubing	DIN Rail Mount	Form C	81 513 501	-

Type	Output	Adjustment Range	Hysteresis	Protection
 Vacuum Detection	5A @ 230 V	-0.3 → -0.8 bar	Max. 250 mb	IP20
		-0.3 → -0.9 bar	Max. 250 mb	IP 54
		-0.3 → -0.8 bar	Max. 250 mb	IP 54



Connection	Mounting	Contact Form	Standard P/N	ATEX Compliant P/N
Push-in connection Ø 4 mm for semi-rigid tubing	DIN Rail Mount	Form C	81 513 522	-
	Sub-base Mount		81 513 527	-
1/8 Inch BSP (British Standard Pipe Thread Size)	Panel Mount (via 2 x M4 Screws)		81 513 523	-

**MOUNTING BASES FOR AIR PRESSURE/VACUUM SENSORS**

Type	Mounting	Connection	Note
 Sub-base	DIN Rail Mount	Rotable Push-in Connection	Base that allows to connect several products next to each other
	DIN Rail Mount		Base for standalone use of one product only
 Sub-base	Shaft Mount (Ø 8 mm) via clip	Rear Connection	Base for the use of up to two products
 Sub-base	Panel Mount via 2 x M4 screw	Rear Connection	Base for standalone use of one product only

Standard P/N	ATEX Compliant P/N
81 532 102	81 532 109
81 532 104	81 532 111
81 531 001	81 531 008
81 532 001	81 532 009

**PNEUMATIC PROXIMITY SENSORS**

Type	Proximity Detection Distance	Operating Pressure	Output Pressure	Consumption at operating pressure 0.5 b
 Passage Sensor	18 mm	0.5 → 2.5 bar	5 mbar	70 NL/h
 Passage Sensor	100 mm	0.5 → 2.5 bar	5 mbar	100 NL/h

Consumption at operating pressure 2.5 b	Connection	Standard P/N	ATEX Compliant P/N
2200 NL/h	Push-in connection Ø 4 mm for barb connection Ø 2.7 x 4 mm	81 372 201	-
700 NL/h		81 372 401	-

**PNEUMATIC MICROSWITCHES**

Type	Contact	Actuator	Activation Force at 4 bar	Operating Pressure
 V3 Type Pneumatic Switch	Normally Open	Pin Plunger	< 0,5 N	3 → 8 bar
	Normally Closed			

Flow at 4 bar	Orifice Diameter	Connection	Standard P/N	ATEX Compliant P/N
100 NL/min	2 mm	Push-in connection Ø 4 mm for barb connection Ø 2.7 x 4mm	81 290 501	81 290 506
			81 290 001	81 290 006

## PNEUMATIC LIMIT SWITCHES

### Vertical Style

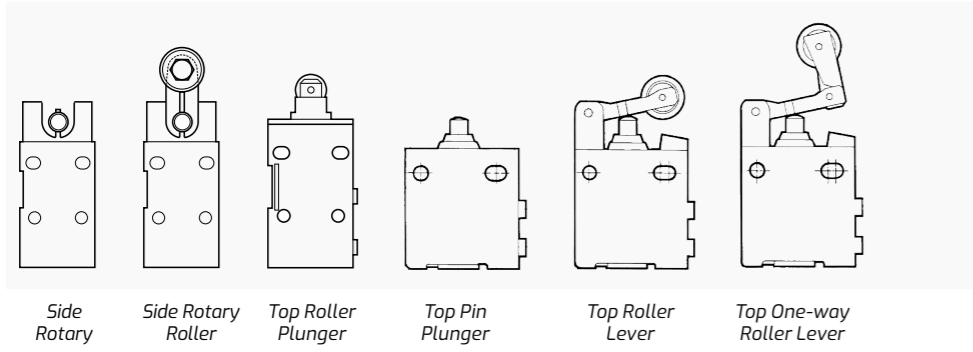

### Horizontal Style

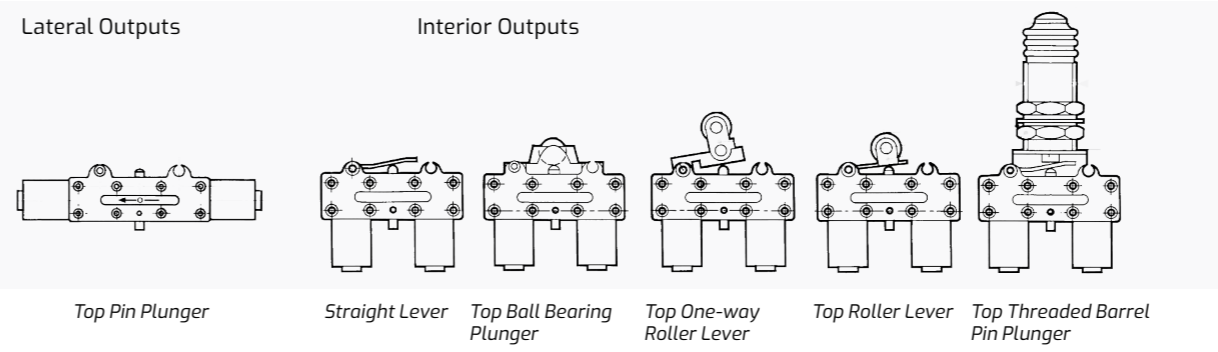

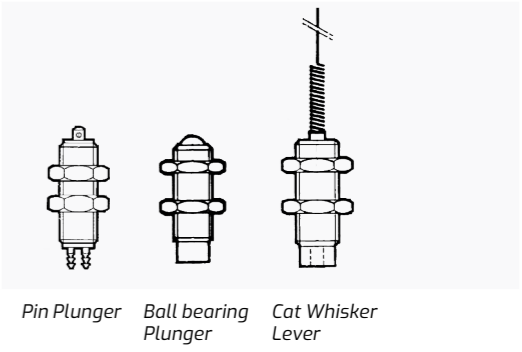

### Threaded Barrel-Style





## PNEUMATIC LIMIT SWITCHES - VERTICAL STYLE

Type	Actuator	Contact	Connection	Operating Pressure	Flow at 6 bar	Orifice Diameter	Activation Force at 6 bar	Standard P/N	ATEX Compliant P/N
 <b>Standard Size</b> Limit Switch	Top Roller Plunger	Normally Closed	Push-in connection Ø 4 mm for semi-rigid tubing	0.1 → 8 bar	200 Nm <sup>3</sup> /h	3 mm	2.5 daN	81 922 401	-
	Side Rotary		81 922 010					-	
	Side Rotary		81 922 210					-	
	Side Rotary Roller		81 922 205					-	
 <b>Compact Size</b> Limit Switch	Top Pin Plunger	Normally Closed	Push-in connection Ø 4 mm for semi-rigid tubing	0.1 → 8 bar	200 NL/min	2.7 mm	18 N	81 921 501	-
 <b>Compact Size</b> Limit Switch	Top Roller Lever (Plastic)	Normally Open	Push-in connection Ø 6 mm for semi-rigid tubing					81 921 901	-
		Normally Closed						81 921 701	-
		Normally Open						81 921 911	-
 <b>Compact Size</b> Limit Switch	Top Roller Lever (Metal)	Normally Closed	Push-in connection Ø 6 mm for barb connection Ø 2.7 x 4 mm					81 921 719	-
		Normally Closed	Push-in connection Ø 6 mm for semi-rigid tubing - M5 Pneumatic Silencer					81 921 806	-
			Normally Open					Push-in connection Ø 4 mm for semi-rigid tubing	81 921 912
		Normally Closed	Push-in connection Ø 4 mm for semi-rigid tubing					81 921 702	-
			Normally Open					Push-in connection Ø 4 mm for barb connection Ø 2.7 x 4 mm	81 921 714
 <b>Compact Size</b> Limit Switch	Top One-way Roller Lever	Normally Closed	Push-in connection Ø 6 mm for semi-rigid tubing					81 921 902	-
			Push-in connection Ø 6 mm for barb connection Ø 2.7 x 4 mm	81 921 717	-				
			Push-in connection Ø 4 mm for semi-rigid tubing	81 921 707	-				
	Top Threaded Barrel Pin Plunger				200 NL/min	2.7 mm	18 N	81 921 505	-

**PNEUMATIC LIMIT SWITCHES - HORIZONTAL STYLE**

Type	Actuator	Contact	Connection	Operating Pressure	Flow at 6 bar	Orifice Diameter	Activation Force at 6 bar	Standard P/N	ATEX Compliant P/N
 <b>Miniature Limit Switch</b> Lateral Outputs	Top Pin Plunger	Normally Open	Push-in connection Ø 4 mm for semi-rigid tubing	2 → 8 bar	200 NL/min	2.7 mm	15 N	81 280 010	-
		Normally Closed						81 280 510	-
 <b>Miniature Limit Switch</b> Interior Outputs	Top Pin Plunger	Normally Open	Push-in connection Ø 4 mm for semi-rigid tubing	2 → 8 bar	200 NL/min	2.7 mm	15 N	81 281 010	-
		Normally Closed						81 281 510	-
	Top Ball Bearing Plunger	Normally Closed						81 281 504	-
	Top Threaded Barrel Pin Plunger	Normally Closed						81 737 501	-
	Top Short Lever	Normally Closed						81 281 502	-
	Top Roller Lever	Normally Closed						81 281 509	-
Top One-way Roller Lever	Normally Closed	81 281 508	-						



**PNEUMATIC LIMIT SWITCHES - THREADED BARREL STYLE**

Type	Actuator	Contact	Connection	Operating Pressure	Flow at 6 bar	Orifice Diameter	Activation Force at 6 bar	Standard P/N	ATEX Compliant P/N
 <b>Standard Version</b>	Pin Plunger	Normally Closed	Push-in connection Ø 4 mm for barb connection Ø 2.7 x 4mm	0.1 → 8 bar	130 Nm <sup>3</sup> /h	2 mm	16 N	81 923 001	-
 <b>Low-force Version</b> (To be used with output modules)	Ball Bearing Plunger	Via Output Module	Push-in connection Ø 4 mm for semi-rigid tubing	Via Output Module	Via Output Module	Via Output Module	0.8 N	81 512 201	-
	Cat Whisker Lever						0.025 N	81 512 401	-

**OUTPUT MODULES FOR THREADED BARREL STYLE LIMIT SWITCHES**

Type	Actuator	Contact	Mounting	Operating Pressure	Flow at 6 bar	Orifice Diameter	Activation Force at 6 bar	Standard P/N	ATEX Compliant P/N
 <b>Positive</b> Output Module	Low-force threaded barrel style limit switches	Normally Open	Sub-base Mount	2 → 8 bar	170 NL/min	2.7 mm	-	81 502 435	-
		Normally Closed						81 505 435	-



### MANUALLY OPERATED PNEUMATIC SWITCHES

Type	Actuator	Contact	Connection	Color	Standard P/N	ATEX Compliant P/N
 <b>Toggle Switch</b>	Toggle with automatic return (3 Positions)	Normally Closed	Push-in connection Ø 4 mm for semi-rigid tubing	Black	81 715 511	-
				Red	81 715 512	-
	Toggle with manual return (3 Positions)			Black	81 716 511	-
				Red	81 716 512	-
 <b>Push Button</b>	Single Push Button	Normally Open	Black	81 735 011	-	
		Normally Closed	Black	81 735 511	-	
	Red		81 735 512	-		
	Black/Red		81 733 511	-		
	Double Push Button					

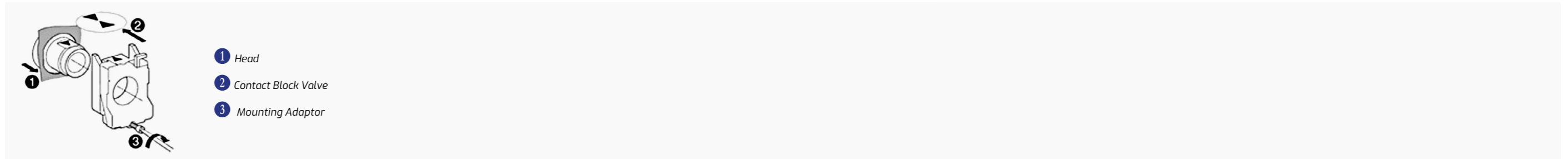
### MANUALLY OPERATED PNEUMATIC SWITCHES - TO BE ASSEMBLED



#### 1 HEADS

Type	Actuator	Size	Color	Standard P/N	ATEX Compliant P/N
 <b>Flush Push Button Head</b>	Single Push Button	Ø 22 mm	Black	24 678 127	-
			Green	24 678 128	-
			Red	24 678 129	-
 <b>Emergency Stop Push Button Head</b>	Single Push Button	Ø 22 mm	Red	24 678 173	-
	Single Push Button		Black	24 678 172	-
	Single Push & Turn Button		Red	24 678 171	-
 <b>Selector Switch Head</b>	Short Handle (2 Positions)	Ø 22 mm	Black	24 678 174	-
	Long Handle (2 Positions)			24 678 175	-
	Short Handle (3 Positions)		Black	24 678 176	-
	Short Handle with spring return (3 Positions)			24 678 178	-

#### 2 CONTACT BLOCK VALVES





Type	Actuator	Contact	Connection	Operating Pressure	Flow at 4 bar	Orifice Diameter	Control Force	Standard P/N	ATEX Compliant P/N
 <b>Contact block valve - 3 Outputs / 2 Positions (3/2)</b>	-	Normally Closed	Push-in connection Ø 4 mm for semi-rigid tubing	0 → 10 bar	90 Nl/min	2 mm	12.6 N	89 543 501	-
		Normally Open						89 543 101	-
	-	Normally Closed	1/8 Inch BSP					89 543 701	-
		Normally Open	(British Standard Pipe Thread Size)					89 543 201	-

Type	Actuator	Contact	Connection	Operating Pressure	Flow at 4 bar	Orifice Diameter	Control Force	Standard P/N	ATEX Compliant P/N
 <b>Kit - Contact block valve + mounting adaptor - 3 Outputs / 2 Positions (3/2)</b>	-	Normally Closed	Push-in connection Ø 4 mm for semi-rigid tubing	0 → 10 bar	90 NI/min	2 mm	12.6 N	89 543 105	-
		Normally Open						89 543 005	-
		Normally Closed + Normally Open						89 543 305	-
		Normally Closed + Normally Closed						89 543 205	-

### 3 MOUNTING ADAPTORS

Type	Actuator	Contact	Connection	Operating Pressure	Flow at 4 bar	Orifice Diameter	Control Force	Standard P/N	ATEX Compliant P/N
 Mounting adaptor	-	-	-	-	-	-	-	24 679 702	-

### SAFETY-START MODULES

Type	Actuator	Standard	Mounting	Connection	Flow at 4 bar	Orifice Diameter	Control Force	Standard P/N	ATEX Compliant P/N
 <b>Safety Start (Logic Block)</b>	-	Type III A	Sub-base Mount	-	2 → 8 bar	0.2 s	2.5 N	81 580 101	-
 <b>Safety Start (Logic Block)</b>		Type III B	-	Push-in connection Ø 4 mm for semi-rigid tubing				81 580 202	-
 <b>Safety Start (Complete Two-Hand Module)</b>	Double button	Type III A	-	Push-in connection Ø 4 mm for semi-rigid tubing				81 580 504	-
 <b>Safety Start (Complete Two-Hand Module)</b>		Type III B						81 580 503	-

### MOUNTING BASE FOR SAFETY START MODULES (LOGIC BLOCK)



Type	Mounting	Connection	Note	Standard P/N	ATEX Compliant P/N
 Sub-base	Panel Mount (via 2 x M4 Screws)	Rear Connection	Base for standalone use of one product only	81 532 001	81 532 009

# Selection Guide – Pneumatic Logic Control

## TIMERS (TIMING ELEMENTS)

Type	Timing	Flow at 6 bar	Orifice Diameter	Operating Pressure	Mounting	Optional Set-up Knob	Standard P/N	ATEX Compliant P/N
 <b>Positive Output (ON-delay)</b>	Fixed: 0.4 s	170 NL/min	2.7 mm	2 → 8 bar	Sub-base Mount	-	81 503 540	81 503 543
	Adjustable: 0.1 → 15 s					79 451 698	81 503 710	81 503 728
	Adjustable: 0.1 → 30 s					79 451 903	81 503 720	81 503 729
	Adjustable: 0.1 → 60 s					-	81 503 725	81 503 731
 <b>Negative Output</b>	Adjustable: 0.1 → 15 s	170 NL/min	2.7 mm	2 → 8 bar	Sub-base Mount	79 451 698	81 506 710	-
	Adjustable: 0.1 → 30 s					79 451 903	81 506 720	-
	Adjustable: 0.1 → 60 s					-	81 506 725	-
 <b>Impulse Generator</b>	Fixed: 0.4 s	170 NL/min	2.7 mm	2 → 8 bar	Sub-base Mount	-	81 507 540	81 507 543
	Adjustable: 0.1 → 30 s					79 451 904	81 507 720	81 507 724
 <b>Frequency Generator</b>	Adjustable: 0.02 → 8 Hz	170 NL/min	2.7 mm	2 → 8 bar	Sub-base Mount	79 451 905	81 506 940	81 506 945
	Adjustable: 0.02 → 14 Hz					-	81 506 920	-

## MOUNTING BASES FOR TIMERS

Type	Mounting	Connection	Note	Standard P/N	ATEX Compliant P/N
 Sub-base	DIN Rail Mount	Rotable Push-in Connection	Base that allows to connect several products next to each other	81 532 102	81 532 109
	DIN Rail Mount		Base for standalone use of one product only	81 532 104	81 532 111
 Sub-base	Shaft Mount (Ø 8 mm) via clip	Rear Connection	Base for the use of up to two products	81 531 001	81 531 008
 Sub-base	Panel Mount via 2 x M4 screw	Rear Connection	Base for standalone use of one product only	81 532 001	81 532 009

## TIMING FUNCTIONS

### Positive Output (ON-delay)

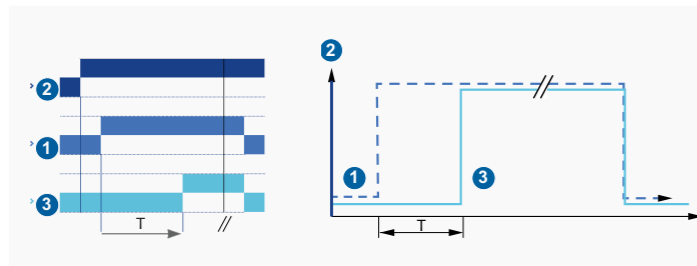

### Negative Output

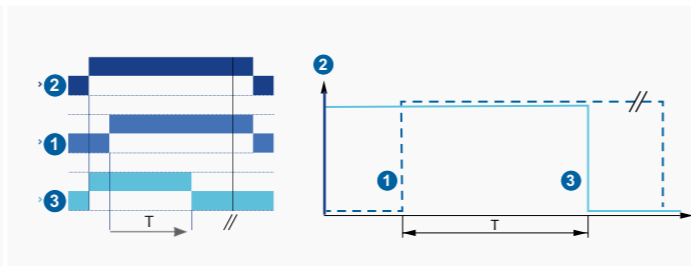

### Impulse Generator

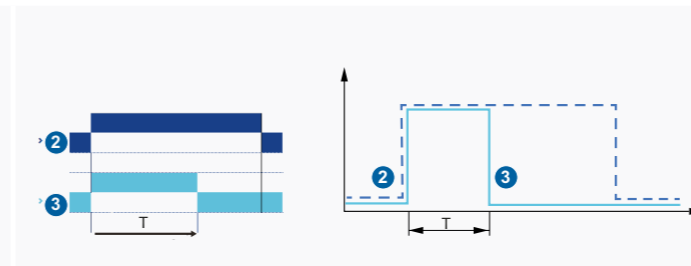

### Frequency Generator

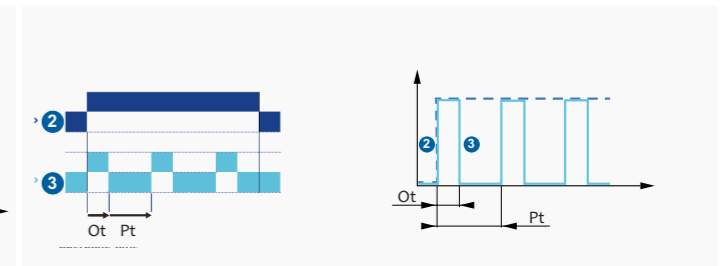

- 1 Control input
- 2 Air supply
- 3 Air Output

T: Timing  
// Supply off

- 1 Control input
- 2 Air supply
- 3 Air Output





T: Timing  
// Supply off

- 2 Air supply
- 3 Air Output
- T: Timing

- 2 Air supply
- 3 Air Output



TO: Operating time  
Pt: Period time

## LOGIC GATES (LOGIC ELEMENTS)

Logic Function	Logic Expression	Mounting	Flow at 6 bar
 <b>OR</b>	$S = a + b$	Sub-base Mount	170 NL/min
		Push-in connection Ø 4 mm for semi-rigid tubing	200 NL/min
		Push-in connection Ø 6 mm for semi-rigid tubing	200 NL/min
 <b>AND</b>	$S = a . b$	Sub-base Mount	170 NL/min
		Push-in connection Ø 4 mm for semi-rigid tubing	150 NL/min
		Push-in connection Ø 6 mm for semi-rigid tubing	200 NL/min
 <b>YES (Buffer)</b>	$S = a$	Sub-base Mount	170 NL/min
<b>YES (Buffer) with threshold</b>	$S = a$		
 <b>NOT (Inverter)</b>	$S = \bar{a}$	Sub-base Mount	170 NL/min
<b>NOT (Inverter) with threshold</b>	$S = \bar{a}$		

	Orifice Diameter	Operating Pressure	Color	Standard P/N	ATEX Compliant P/N
	2.7 mm	2 → 8 bar	Blue	81 521 501	81 521 508
	2.7 mm			81 540 001	81 540 015
	4 mm			81 540 005	-
	2.7 mm	2 → 8 bar	Green	81 522 501	81 522 505
				81 541 001	81 541 015
				81 541 005	81 541 017
	2.7 mm	2 → 8 bar	Yellow	81 501 025	81 501 031
				81 503 025	81 503 028
				81 504 025	81 504 035
	2.7 mm	2 → 8 bar	Dark Gray	81 506 025	81 506 027

### MOUNTING BASES FOR LOGIC GATES

Type	Mounting	Connection	Note	Standard P/N	ATEX Compliant P/N
 Sub-base	DIN Rail Mount	Rotable Push-in Connection	Base that allows to connect several products next to each other	81 532 102	81 532 109
	DIN Rail Mount		Base for standalone use of one product only	81 532 104	81 532 111
 Sub-base	Shaft Mount (Ø 8 mm) via clip	Rear Connection	Base for the use of up to two products	81 531 001	81 531 008
 Sub-base	Panel Mount via 2 x M4 screw	Rear Connection	Base for standalone use of one product only	81 532 001	81 532 009



### MEMORY MODULES (MEMORY ELEMENTS)

Type	Flow at 6 bar	Orifice Diameter	Min. Pilot Pressure	Operating Pressure	Mounting	Color	Standard P/N	ATEX Compliant P/N
 Bistable Bistable with Manual Override	200 NL/min	2.7 mm	2.5 bar	2 → 8 bar	Sub-base Mount	Black	81 523 201	81 523 205
							81 523 601	81 523 608



### MOUNTING BASES FOR MEMORY MODULES

Type	Mounting	Connection	Note	Standard P/N	ATEX Compliant P/N
 Sub-base	DIN Rail Mount	Rotable Push-in Connection	Base for standalone use of one product only	81 542 002	81 542 004

### SEQUENCERS (SEQUENTIAL ELEMENTS)

Type	Version	Flow at 6 bar	Orifice Diameter	Operating Pressure	Mounting	Mechanical life	Standard P/N	ATEX Compliant P/N
 Basic Sequencer Modules	Maintained reset	150 NL/min	2.7 mm	2 → 8 bar	Sub-base Mount	5 x 10*6 at 6 bar	81 550 001	81 550 013
	Auto reset						81 550 201	81 550 213
 Shift Register Sequencer Module	Maintained reset						81 550 401	81 550 403
	Auto reset						81 550 601	81 550 603

### MOUNTING BASES FOR SEQUENCERS

Type	Mounting	Notes	Standard P/N	ATEX Compliant P/N
 Sub-base	DIN Rail Mount	Pressure Indicators & Rotable Push-in Connection	81 551 101	81 551 104
	Shaft Mount (Ø 8 mm) via clip	-	81 551 001	-
 End-base	DIN Rail Mount	Pressure Indicators & Rotable Push-in Connection	81 552 101	81 552 105
	Shaft Mount (Ø 8 mm) via clip	Pressure Indicators	81 552 001	-
 Diversion Base Module	DIN Rail Mount	Pressure Indicators & Rotable Push-in Connection	81 552 601	81 552 605

# Selection Guide – Pneumatic Indicators

## PNEUMATIC PILOT LIGHTS



Type	Color	Connection	Panel Cut	Size	Operating Pressure	Standard P/N	ATEX Compliant P/N
 Pilot Lights	Red	Push-in connection Ø 4 mm for semi-rigid tubing	22.5 mm	Ø 30 mm	2 → 8 bar	84 150 201	84 150 214
	Green					84 150 202	84 150 215
	Yellow					84 150 203	84 150 216
	Blue					84 150 204	-

## PNEUMATIC COUNTERS



Type	Digits	Size	Pressure to break	Pressure to make	Supply Pressure	Mounting	Standard P/N	ATEX Compliant P/N
 Totalizer (+ Reset)	4 Digits	24 x 48 mm	< 0.3 bar	> 1.4 bar	2 → 8 bar	Screw Mount	99 766 002	-

# Selection Guide – Solenoid Valves

## SOLENOID VALVES

Type	Contact	Flow at 6 bar	Orifice Diameter	Operating Pressure	Switching time	Size	Supply Voltage	Mounting	Standard P/N	ATEX Compliant P/N
 3 Outputs / 2 Positions (3/2) 4 Outputs / 2 Positions (4/2 Monostable)	NC	200 NI/min	3 mm	3 → 8 b	20 ms	17.5 mm	24 VDC	DIN Rail Mount	81 513 103	-
	-					35 mm			81 513 203	-
 3 Outputs / 2 Positions (3/2)	NC	170 NI/min	2.7 mm	2 → 8 b	-	With manual override by impulse	24 VDC	Sub-base Mount	81 519 732	-
							24 VAC		81 519 774	-
							110 VAC		81 519 776	-
							220-230 VAC		81 519 777	-



### MOUNTING BASES FOR SOLENOID VALVES

Type	Mounting	Connection	Note	Standard P/N	ATEX Compliant P/N
 Sub-base	DIN Rail Mount	Rotable Push-in Connection	Base that allows to connect several products next to each other	81 532 102	81 532 109
	DIN Rail Mount		Base for standalone use of one product only	81 532 104	81 532 111
 Sub-base	Shaft Mount (Ø 8 mm) via clip	Rear Connection	Base for the use of up to two products	81 531 001	81 531 008
 Sub-base	Panel Mount via 2 x M4 screw	Rear Connection	Base for standalone use of one product only	81 532 001	81 532 009

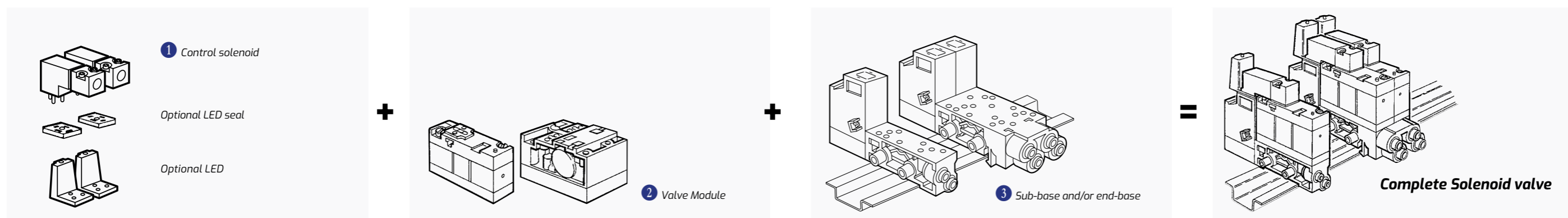
### SOLENOID VALVES - TO BE ASSEMBLED



### 1 CONTROL SOLENOID

Type	Contact	Flow at 6 bar	Orifice Diameter	Mounting	Connection	Switching time	Override	Supply Voltage	Standard P/N	ATEX Compliant P/N
 3 Outputs / 2 Positions (3/2)	Normally Closed	25 NI/min	0.8 mm	Valve Module Mount	Plug-In	5 - 15 ms	-	24 VDC	81 519 032	81 519 035
							By impulse		81 519 332	81 519 335
							Manual (maintained)		81 519 340	81 519 037
 3 Outputs / 2 Positions (3/2)	Normally Closed	12 NI/min	0.5 mm	Valve Module Mount	Plug-In	5 - 15 ms	-	24 VAC - 50/60 Hz	81 519 080	-
							By impulse		81 519 380	-
							Manual (latching 1/4 turn)	81 519 680	-	
							By impulse	48 VAC - 50/60 Hz	81 519 381	-
							By impulse	110 VAC - 50/60 Hz	81 519 378	-
							Manual (latching 1/4 turn)		81 519 678	-
							By impulse	220/230 VAC - 50/60 Hz	81 519 379	-
Manual (latching 1/4 turn)	81 519 679	-								



### OPTIONAL LEDES & SEAL

Type	Supply Voltage	Mounting	Standard P/N	ATEX Compliant P/N
 LEDs (Visual indicators with anti-surge)	24 V - 50/60 Hz	Between control solenoid & valve module	81 513 052	-
	110 V - 50/60 Hz		81 513 058	-
	230 V - 50/60 Hz		81 513 059	-
LED Seal	12 → 24 V AC/DC		81 513 064	-





### 2 VALVE MODULES

Type	Operation	Contact	Flow at 6 bar	Orifice Diameter	Switching time	Size	Operating Pressure	Mounting	Standard P/N	ATEX Compliant P/N
 3 outputs / 2 Positions - (3/2)	Monostable	NC	200 Nl/min	3 mm	15 ms	17.5 mm	3 → 8 b	Sub-base Mount	81 513 100	81 513 196
		NO							81 513 600	-
4 outputs / 2 Positions - (4/2)	Monostable	-	300 Nl/min	4 mm					81 513 200	81 513 234
4 outputs / 2 Positions - (4/2)	Monostable	-							81 516 100	-
	Bistable	-			50 ms	35 mm	3 → 8 b	Sub-base Mount	81 516 200	81 516 208

### 3 SUB-BASES & END-BASES





Type	Mounting	Connection	Size	Standard P/N	ATEX Compliant P/N
 Sub-base	DIN Rail Mount	Push-in connection Ø 4mm for semi-rigid tubing	17.5 mm	81 513 060	81 513 075
			35 mm	81 517 101	-
		Push-in connection Ø 6mm for semi-rigid tubing	17.5 mm	81 513 065	81 513 076
			35 mm	81 517 201	81 517 206
 End-Bases		Push-in connection Ø 6mm for semi-rigid tubing	2 x 17.5 mm	81 513 011	81 513 040
 Intermediary supply module			17.5 mm	81 513 001	81 513 039

### GENERAL ACCESSORIES

Type	Note	Mounting	Standard P/N	ATEX Compliant P/N
 Pneumatic Silencer	Filter to avoid dust	Push-in connection Ø 6 mm for semi-rigid tubing	81 537 001	-
 Connector	For control solenoid		81 516 082	-
 Pneumatic Pilot	Without manual override	Push-in connection Ø 4 mm for semi-rigid tubing	81 516 081	81 516 093
 Blanking Plate	For spare positions		81 516 085	-

# Selection Guide – Pneumatic Circuit Components & Boards

## AIR FLOW CONTROL COMPONENTS

Type	Flow	Orifice Diameter	Operating Pressure	Mounting	Connection	Standard P/N	ATEX Compliant P/N
 <b>Air Flow Regulator</b>	Free flow 30 NL/min	0 → 0.5mm	1 → 8 bar	Sub-base Mount	-	81 525 101	-
	Free flow 200 NL/min	0 → 1.7mm				81 526 001	-
 <b>Air Flow Regulator</b>	Flow at 4 bar 0.18 → 0.30 Nm <sup>3</sup> /h	Ø 0.3mm	1 → 8 bar	-	Push-in connection Ø 4 mm for semi-rigid tubing	81 529 003	81 529 013
	Flow at 4 bar 0.35 → 0.5 Nm <sup>3</sup> /h	Ø 0.4mm				81 529 004	81 529 014
	Flow at 4 bar 0.58 → 0.77 Nm <sup>3</sup> /h	Ø 0.5mm				81 529 005	-
	Flow at 4 bar 0.80 → 1.06 Nm <sup>3</sup> /h	Ø 0.6mm				81 529 006	-
	Flow at 4 bar 1.10 → 1.39 Nm <sup>3</sup> /h	Ø 0.7mm				81 529 007	81 529 017
	Flow at 4 bar 1.45 → 1.65 Nm <sup>3</sup> /h	Ø 0.8mm				81 529 008	81 529 018
	Flow at 4 bar 2.30 → 2.80 Nm <sup>3</sup> /h	Ø 1mm				81 529 010	-
	Flow at 4 bar 0.08 → 0.12 Nm <sup>3</sup> /h	Ø 0.25mm				81 529 025	-
 <b>Air Pressure Regulator</b>	Flow at 6 bar 200 NL/min	-	2 → 8 bar (Adjustable output pressure 0.1 → 8 bar)	Sub-base Mount	-	81 527 001	-
 <b>Non-return valve (Check-Valve)</b>	Flow at 6 bar 200 NL/min	-	2 → 8 bar	-	Push-in connection Ø 4 mm for semi-rigid tubing	81 529 901	-



## AIR CAPACITOR

Type	Timing	Connection	Standard P/N	ATEX Compliant P/N
 <b>Air Capacitor</b>	10 → 60s	Push-in connection Ø 4 mm for semi-rigid tubing	79 452 808	-



## AIR SIGNAL AMPLIFIERS

Type	Function	Engaging Pressure	Orifice Diameter	Consumption at 4bar	Acceptable Overload for 1h	Mounting	Standard P/N	ATEX Compliant P/N
 <b>Simple Amplifiers</b>	Positive	10 → 20 mb	2.5 mm	5 NL/min	800 mb	Sub-base Mount	81 502 230	81 502 238
	Negative						81 505 230	81 505 231

### VACUUM GENERATORS

Type	Mounting	Connection	Operating Pressure	Standard P/N	ATEX Compliant P/N
 Vacuum Generators	Sub-base Mount	-	2 → 8 bar	81 535 301	-
 Vacuum Generators	-	Push-in connection Ø 4 mm for semi-rigid tubing		81 545 001	81 545 012
	-	Push-in connection Ø 6 mm for semi-rigid tubing		81 545 005	-

### MOUNTING BASES FOR PNEUMATIC CIRCUIT COMPONENTS

Type	Mounting	Connection	Note	Standard P/N	ATEX Compliant P/N
 Sub-base	DIN Rail Mount	Rotable Push-in Connection	Base that allows to connect several products next to each other	81 532 102	81 532 109
	DIN Rail Mount		Base for standalone use of one product only	81 532 104	81 532 111
 Sub-base	Shaft Mount (Ø 8 mm) via clip	Rear Connection	Base for the use of up to two products	81 531 001	81 531 008
 Sub-base	Panel Mount via 2 x M4 screw	Rear Connection	Base for standalone use of one product only	81 532 001	81 532 009

### SUPPLY BLOCK

Type	Mounting	Connection	Standard P/N	ATEX Compliant P/N
 Supply Block 13 Outputs	Shaft Mount (Ø 8 mm) via clip	Rear Connection	81 536 801	-

### PNEUMATIC BOARDS

Contact our DesignLAB for tailor-made pneumatic boards

